

**UNCLASSIFIED**

SECURITY WARNING

This document is classified CONFIDENTIAL and must be handled in accordance with the existing regulations pertaining to information classified CONFIDENTIAL.

THE UNAUTHORIZED RETENTION OR DESTRUCTION OF THIS DOCUMENT IS PROHIBITED.

This brochure has been specially prepared for Avro Aircraft Limited. The information and data contained herein is the property of Avro Aircraft Limited and the recipient shall not transfer, copy, reprint, divulge or use any portion of it without the prior consent of Avro Aircraft Limited.

Classification cancelled/changed to.....

by authority of..... (date).....

Signature *[Handwritten Signature]*

This is copy number ... 66 ...

issued to .....

Date .....

**UNCLASSIFIED**

**UNCLASSIFIED**

# ARROW 2 ICE PROTECTION SYSTEM

REPORT NO. 72/SYSTEMS 20/51

JUNE 1957

This brochure is intended to provide an accurate description of the system(s) or service(s) for purposes of the Arrow 2 Mock-up Conference, and is not to be considered binding with respect to changes which may occur subsequent to the date of publication.

COMPILED BY D. R. Rastan.APPROVED BY Alan R. Bulay

ENGINEERING DIVISION

**AVRO AIRCRAFT LIMITED**

MALTON — ONTARIO

ARROW 2 PROTECTION AGAINST ICE

TABLE OF CONTENTS

		PAGE
1.	Introduction	1
1.1	Airfoil Surface	1
1.2	Windshield and Canopy Windows	2
1.3	Engine Intakes	2
1.4	Radome	3
2.	Windshield and Canopy Windows	4
2.1	Transparencies	4
2.2	Power Input	4
2.3	Temperature Control	4
3.	Engine Intakes	6
3.1	Power Available	6
3.2	Regions De-Iced	6
3.3	Principles of Operation	7
3.3.1	System for One Engine Intake	7
3.3.2	System for Both Engine Intakes	8
3.3.3	Ice Detectors	9

## TABLE OF CONTENTS (Cont'd)

		PAGE
3.3.4	The Controller	9
3.3.5	The Power Distributor	10
3.3.6	The Ice Protectors	10
3.3.7	Overheat Protection	11
3.3.8	Description of Installation	11
3.3.8.1	Equipment	12
3.3.8.2	Protectors	12
3.3.8.3	Overheat Switches	13
4.	Radome De-Icing	14
4.1	Principles of Operation	14
4.2	Installation	16
4.2.1	Alcohol Tank	16
4.2.2	Ice Detector	16
4.2.3	Time Delay Relay	16
4.2.4	Air Supply	16
4.2.5	Distributor	17



LIST OF ILLUSTRATIONS

		PAGE
Figure 1	Windshield and Canopy De-Icing	18
Figure 2	De-Icing Equipment	19
Figure 3	Block Diagram of Intake De-Icing	20
Figure 4	Ice Detector - Principle of Operations	21
Figure 5	Duct De-Icing	22
Figure 6	Boot Construction and Installation of Overheat Switch	23
Figure 7	Radome De-Icing System	24
Figure 8	Section Through Distributor	25

## 1. Introduction

Encounters with ice, which endanger the life of the aircraft crew, or seriously interfere with operations, occur very seldom. To avoid penalising the aircraft performance, it is most necessary to ensure that equipment carried is really required. Many aspects of the de-icing system are discussed in detail in the electrical system brochure 72/systems 11/27.

### 1.1 Aerofoil Surfaces

Early in the design stages of the Arrow 2, it was suspected that de-icing of the aerofoil surfaces could be dispensed with. Considering the time likely to be spent in icing conditions, the maximum conceivable ice accretion did not have enough weight to interfere seriously with the ability of the aircraft to climb out of an icing layer, nor did the drag of the accretion interfere with the ability to accelerate to a speed at which the kinetic temperature rise would melt any ice formation. There remained, however, the question of stability and control. Pictures were obtained from the N.A.C.A. of bad ice accretions on a swept aerofoil similar to the Arrow 2 wing. Tests were carried out in the wind tunnel, at Ottawa, on an Arrow 2 wing with similar simulated ice accretions and the aerodynamic characteristics of the wing were measured. No serious effects on stability or control could be detected

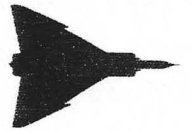

from the tunnel test results. In order to save weight and complication, de-icing of the aerofoil surfaces has been omitted from the Arrow 2.

1.2 Windshield and Canopy Windows

Because of requirements for clear vision, the pilot's windshield, canopy windows and the navigator's window are anti-iced. An electro-thermal method is used. The system is automatic, and no pilot's controls are provided.

1.3 Engine Intakes

Pieces of ice which have formed on the engine intake ramp or lips, and which have become detached, will enter the engine at very nearly the air velocity in the intake. In this way the Arrow 2 differs from most other aircraft where pieces of ice would have a short distance to travel after becoming detached, before entering the engine. The high kinetic energy of such pieces of ice would mean that they are capable of doing considerable damage to compressor blades, if the pieces are large.

The various factors influencing intake design indicated a hot air anti-icing system was impractical. An electro-thermal system was therefore adopted. Because of the prohibitive power requirements of an anti-icing system, a cyclic de-icing system was adopted. It aims at shedding sufficiently small thicknesses of ice for the engine to accept them without

damage. The system is automatic and no pilot's controls are provided.

#### 1.4 Radome

For the aircraft to function as an effective fighting vehicle, the performance of the fire control system must be close to one hundred percent in all conditions. For this reason an alcohol de-icing system is fitted. The system is automatic and no pilot's controls are provided.

UNCLASSIFIED

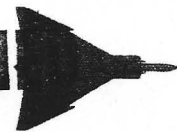

## 2. Windshield and Canopy Windows

The canopy windows and the windshield are heated to ensure clear vision. This includes heating to prevent misting and frosting-up as well as to prevent ice formation on the outside surface.

### 2.1 Transparencies

These transparencies are heated by a conducting layer on the inside surface of the outside sheet of glass. Power is continuously available for this purpose, both on the ground and in flight, and is not dependent on being in icing conditions.

Development work has been carried out on Arrow 2 test windshields; it has been found possible to grade the resistivity of the conducting film, in such a way, that only two heater connections are required on either the windshield, or the canopy window. The areas heated are shown on Fig. 1.

### 2.2 Power Input

115/200 V. - 3 phase power is taken from the aircraft A.C. buses and fed to a 3 phase transformer. Tappings on the transformer give the correct output voltage for the transparencies fitted.

### 2.3 Temperature Control

The power input to the transparencies is regulated by a temperature controller, which works on resistance type sensing elements embedded in the glass. The controller is set to

**UNCLASSIFIED** 

regulate the power input in such a way, as to give temperatures of 110°F at the sensing elements.

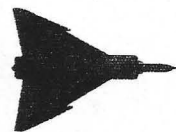

### 3. Engine Intakes

The engine intake lips and ramps are protected by a cyclic de-icing system, the object of which is, to ensure that the pieces of ice entering the engine intakes are sufficiently small to be swallowed without the engines being damaged.

#### 3.1 Power Available

Preliminary studies were made of the anticipated rate of ice accretion, and on the size of the pieces of ice which could be consumed without damage. From this data the power requirements of the system were calculated.

The data on which the calculations were made was, however, of questionable validity, and flight in the Arrow would appear to be the only way in which sound data could be acquired. The order of magnitude obtained was obviously not too wide of the mark.

From this work, total power of 8.3 kvA. per intake was made available to the system. All subsequent design work was based on this quantity.

#### 3.2 Regions De-Iced

After discussions with the N.A.C.A. it was decided to de-ice the complete surface of the intake ramp back to the "hump", and the inside surface of the lips for a distance of approximately 12 inches around the surface from the stagnation point.



**UNCLASSIFIED** 

Fig. 2 shows the extent of the protectors.

### 3.3 Principles of Operation

#### 3.3.1 System for One Engine Intake

An ice detector is located in the engine intake duct. This unit acts as a rate of icing meter by generating an electrical pulse each time .020 inches (approx) of ice builds up on the detecting probe. On receipt of the first pulse from the detector, the icing controller switches on the parting and dividing strips. These strips separate shedding areas, of which there are ten, and ensure clean removal of ice when heat is applied to an area. Before commencing to shed ice it is well to wait until a reasonable thickness of ice has been built up so that aerodynamic forces will remove it cleanly. The icing controller, therefore, waits until it has received a predetermined number of pulses from the detector prior to commencing a shedding cycle.

Having received the requisite number of pulses, the controller then regulates the power distributor to apply power to each of the ten shedding areas in turn. Fig. 1.2.4 shows the location of the shedding areas.

In continuous icing conditions, the ice detector will have been generating pulses throughout the shedding cycle. If sufficient pulses have been received at the icing controller, a second

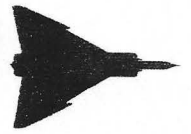

shedding cycle will commence immediately after completion of the first cycle; this process will continue while pulses arrive at the icing controller with sufficient rapidity.

If, at the completion of a shedding cycle, insufficient pulses have been received for a second cycle to commence, the icing controller will wait for the right number of pulses to arrive before initiating a further shedding cycle.

Should the total number of pulses required to initiate a cycle not arrive, the controller will initiate a further shedding cycle on completion of the "Over-Hang-Time" after the arrival of the last pulse. Provided no further signal arrives from the ice detector during the shedding cycle, the system will then shut down.

### 3.3.2 System for Both Engine Intakes

There is one power distributor and one ice detector per engine. However, one icing controller serves both intakes.

Fig. 3 is a block diagram illustrating the system.

When both engines are running, the ice detector on the port side becomes the master detector and the icing controller receives signals from that detector only, providing it is operative. If the R.H. detector is inoperative the L.H. detector will supply signals to the controller. The controller will however, regulate both power distributors to simultaneously control both de-icing systems.



### 3.3.3 The Ice Detectors (Fig. 4)

The ice detector consists of two probes and a pressure switch. Both probes have small holes drilled in their leading and trailing surfaces. These probes are piped to opposite sides of the pressure switch. One probe is continuously heated, while the other is normally unheated.

When ice forms on the unheated probe, pressure falls inside the probe and the pressure switch makes contact. A pulse is delivered to the icing controller and at the same time heating power is applied to the iced-up probe. As soon as the probe de-ices, pressure rises in it breaking the pressure switch contact; removing de-icing power from the probe which is then ready to detect the presence of further icing conditions.

### 3.3.4 The Controller

The controller is the heart of the intake de-icing system. On receipt of the first icing signal it energises a relay(s) which applies power to the parting and dividing strips. It then commences to count icing pulses until a sufficient number arrive to start a shedding cycle. Because the efficiency of catch of the intake lips and ramp is unknown, the required number of pulses to give optimum shedding is also unknown. The controller has, therefore, been made capable of adjustment for the number of pulses required to initiate shedding.

**UNCLASSIFIED** 

Once having initiated shedding, the controller generates pre-determined "Time-On" pulses to the distributors, which supply power to the shedding areas; and with the reception of pulses, transfers the power from one shedding area to the other. Because of the unknowns involved in the system, the unit is capable of adjustment of the "Time-On" pulses which regulate the power-on time to the shedding areas.

The unit also contains a time delay which, when no icing pulses are received during the time setting of the delay, causes a final shedding cycle to be carried out prior to system shut down. This time delay is capable of adjustment.

#### 3.3.5 The Power Distributor

This unit is a stepping contactor carrying the shedding power from the bus bars to the ice protectors. On receipt of signals from the controller, this unit will switch power from one shedding area to another.

#### 3.3.6 The Ice Protectors

Each intake ramp and lip will be covered by seven ice protectors. These protectors, or boots, are of neoprene rubber construction of .065" thickness. One protector covers the tip while two other protectors cover the remainder of the ramp. The other four protectors cover the intake lips.

The intake ramp is split into five shedding regions. Heating is cycled to the boundary layer suction slot. The parting strip on the ramp tip is continuously heated, as are dividing strips between shedding areas. The shedding areas are vertical strips and it is intended to commence shedding at the forward end of the ramp and to systematically work towards the rear.

The protectors for the lips extend around the inside and the outside of the intake for a distance of approximately 18 inches. A parting strip of 1/2" width runs around the stagnation region and is continuously heated. The portion of the protectors outside the intake duct is unheated. The heated region inside the duct extends for approximately 12 inches around the surface from the parting strip. The lips are divided into five shedding areas which are separated by dividing strips. Parting and dividing strips are heated at 20 watts/sq. inch, and shedding areas at 12 watts/sq. inch.

### 3.3.7 Overheat Protection

An overheat switch is located in each shedding area. Any tendency for a shedding area to overheat will result in power being switched off. A similar overheat switch will be located at the critical part of the dividing strips. Fig. 6 shows a section through a protector and an overheat switch.

### 3.3.8 Description of the Installation

Fig. 2 shows an engine intake.

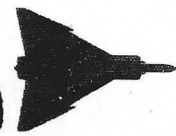

**AVRO ARROW  
UNCLASSIFIED**

### 3.3.8.1 Equipment

With the exception of cabling, overheat switches and the protectors themselves, all components of the intake de-icing system are located together, just behind the protectors on the upper surface of the aircraft, and just inboard of the intake duct.

This equipment is accessible through a large panel. Cables from the protectors arrive at this area via conduits and connect to terminal strips. On the R.H. side of the aircraft the controller, distributor, detector and relays are all located together. A similar installation exists on the L.H. side of the aircraft for the distributor, detector and relays.

### 3.3.8.2 Protectors

The protectors are of neoprene rubber and are supplied by the Goodrich Rubber Company. The intake structure is recessed to the thickness of the protectors which are attached by an adhesive. Except at the tip of the ramp and at the boundary layer bleed, the surface finish of the protectors will be the normal rubber finish. High erosion is, however, expected at the ramp tip, and in this region the boot is covered by a .005" layer of steel foil. A similar layer of steel foil covers the boundary layer bleed, where it is used to conduct heat for small distances across the surface to portions where heating elements cannot be located due to the hole configuration.

**AVRO AIRCRAFT  
UNCLASSIFIED** 

Seven boots cover the protected area. When fitting boots to an intake, trimming the boots to obtain a good fit is permissible.

Trim lines are clearly marked. Gaps between boots may be filled with a filling compound and "buffed up" to give a smooth finish.

### 3.3.8.3 Overheat Switches

Overheat protection is provided by small bi-metallic switches located on the underside of the boots. These switches operate to de-energise power control relays when any one of them overheats. The switches are attached to the boot by a rubber cup, and leads from the switch are carried within the thickness of the boot to the region in which the equipment is mounted.

Switches can be replaced without replacing the boot by peeling the boot back and removing the covering cup.

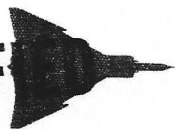

AVRO  
UNCLASSIFIED

#### 4. Radome De-Icing

In the early design stages of the Arrow, consideration was given to hot air and pneumatic type anti-icing and de-icing systems for the radome. It was discovered that radomes of similar shape to the Arrow radome were proving extremely difficult to make with acceptable electrical properties, even when solid laminates were used. Hence the idea of hot air and pneumatic systems was discarded as imposing impossible problems for the radome manufacturers. An alcohol system was therefore adopted.

In this system, alcohol is sprayed from a distributor at the base of the nose boom. By suitable arrangement of the discharge nozzles, this alcohol mixes with the intercepted water and ice on the radome to lower its freezing point such that it flows rearwards to where it no longer interferes with the radar.

##### 4.1 Principles of Operation

Figure 7 is a diagram of the radome de-icing system. The alcohol is contained in a tank of approximately 2.75 gallons capacity. Air pressure at 10-12 psi forces the alcohol from the tank, through the system, to the distributor in the nose boom. Flow control is achieved by means of a signal from the ice detector to a time delay relay, which in turn, actuates a three-way valve.

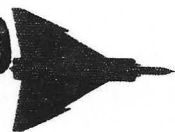
**UNCLASSIFIED**

When ice is detected, the time delay relay energizes the three-way valve to allow the alcohol to flow through the distributor for 1 1/2 seconds. During this period, approximately .04 gallons are dispensed. After 1 1/2 seconds, the time delay relay de-energizes the three-way valve, so that the alcohol flow is shut off, and energises an air valve allowing pressurized air to be released to the distributor. For a period of 22 1/2 seconds this flow of air purges the supply line and distributor, to eliminate a possible source of radar interference.

Provided no further icing signals are received from the detector, the air shut off valve is de-energized and the de-icing operation is complete. The time delay relay has, however, the capacity to store an icing signal. Should a signal arrive during, the period when the supply lines are being purged, it will be stored and, at the end of the purging a further cycle will begin, until such time as no more signals arrive and the system will shut down.

The air supply comes from the low pressure pneumatics system at pressures of from 18 to 85 psi. A pressure reducing valve in the line cuts this pressure to 10-12 psi. before delivering it to the tank. A relief valve is fitted to blow off at 14 psi. in the event of a reducing valve failure. A

**UNCLASSIFIED** 

non-return valve in the supply line prevents a back flow of alcohol into the low pressure pneumatic system.

## 4.2 Installation

### 4.2.1 Alcohol Tank

The tank is situated on the upper side of the nose structure, just forward of the windshield, and is filled from the top by way of a removable filler cap. A gauze filter in the filler neck removes foreign matter and acts as a level gauge. When the tank is full, the liquid level will be just above the bottom of the filter. The de-icing liquid used is denatured alcohol.

### 4.2.2 Ice Detector

The Ice Detector, situated on the underside of the nose structure just forward of the nose wheel well, can be withdrawn after the removal of four screws on the outside of the aircraft.

### 4.2.3 Time Delay Relay

The Time Delay Relay is situated on the upper side of the nose structure and is accessible through the large hinged panel, on the starboard side of the aircraft.

### 4.2.4 Air Supply

The pressure reducing valve, non return valve, pressure relief valve, shut-off valve and three-way valve are all located adjacent to the time delay relay.

The pressure reducing valve will be supplied by The Surface Construction Co., and is presently a standard item.

UNCLASSIFIED

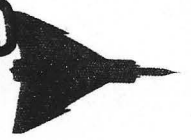

The non-return valve is a standard A. N. part.

The pressure relief valve will be supplied by the Aero Supply Co.

The shut-off valve is a standard item and will be supplied by the Aero Eckel Valve Company.

The three-way valve is to Avrocan Specification No. E221, and will be supplied by Aero Eckel.

4.2.5 Distributor

Piping from the three-way valve to the distributor will be fabricated from plastic Temflex 105 tubing. The distributor consists of a hollow ring around the base of the nose boom, and contains 16 distributing nozzles of .020" dia. drilled to point rearwards at an angle of 45°. Fig. 8 is a section through the distributor.

2032-109-1

POWER INPUT FOR HEATED AREAS OF WINDSHIELD IS AS FOLLOWS:-  
4.3 WATTS PER SQ. INCH, THIS IS CALCULATED ON A HEATFLOW OF 2100 B.T.U.'S. PER HOUR PER SQ. FT.

MAY/57

FIG. 1 WINDSHIELD AND CANOPY DE-ICING

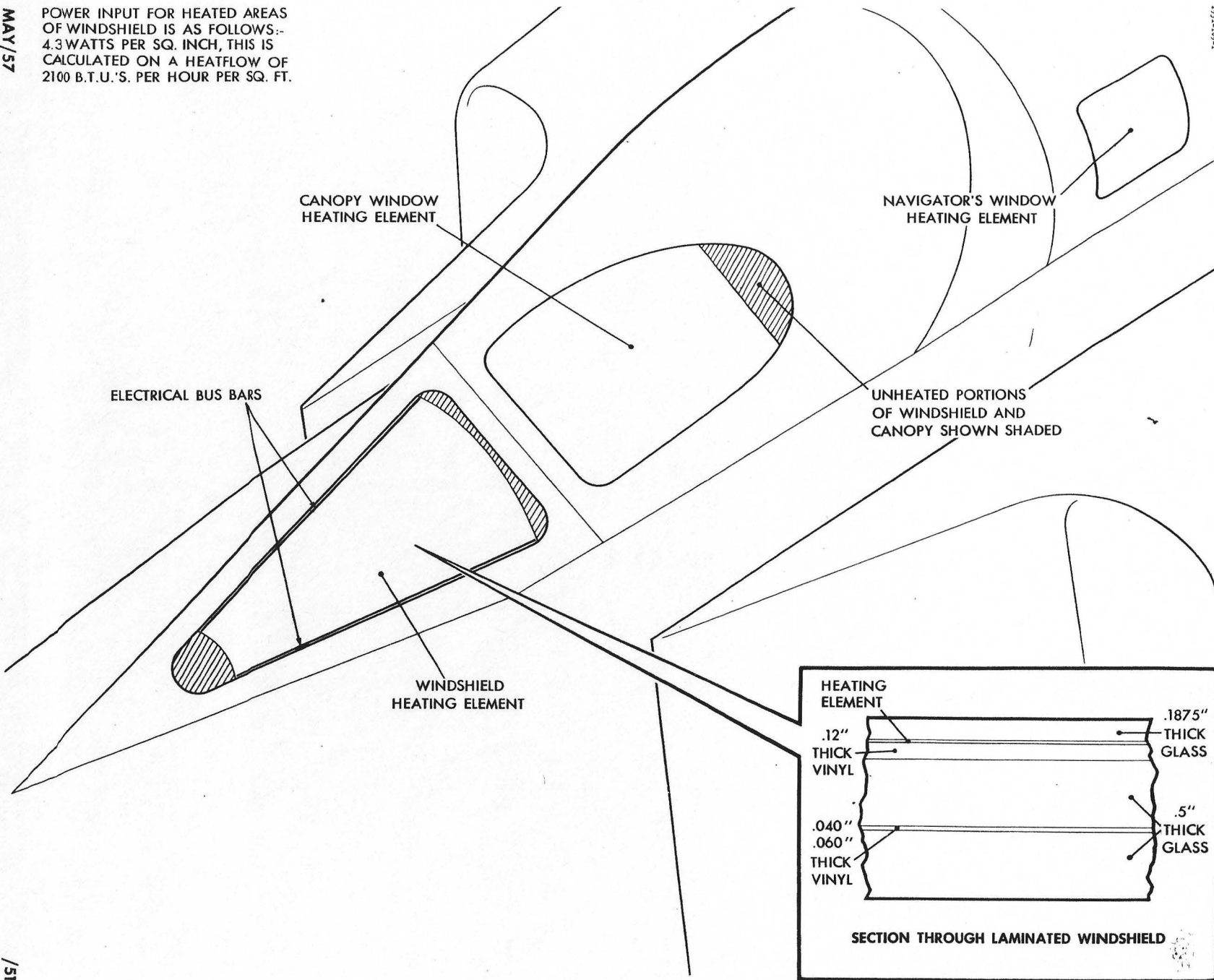

UNCLASSIFIED

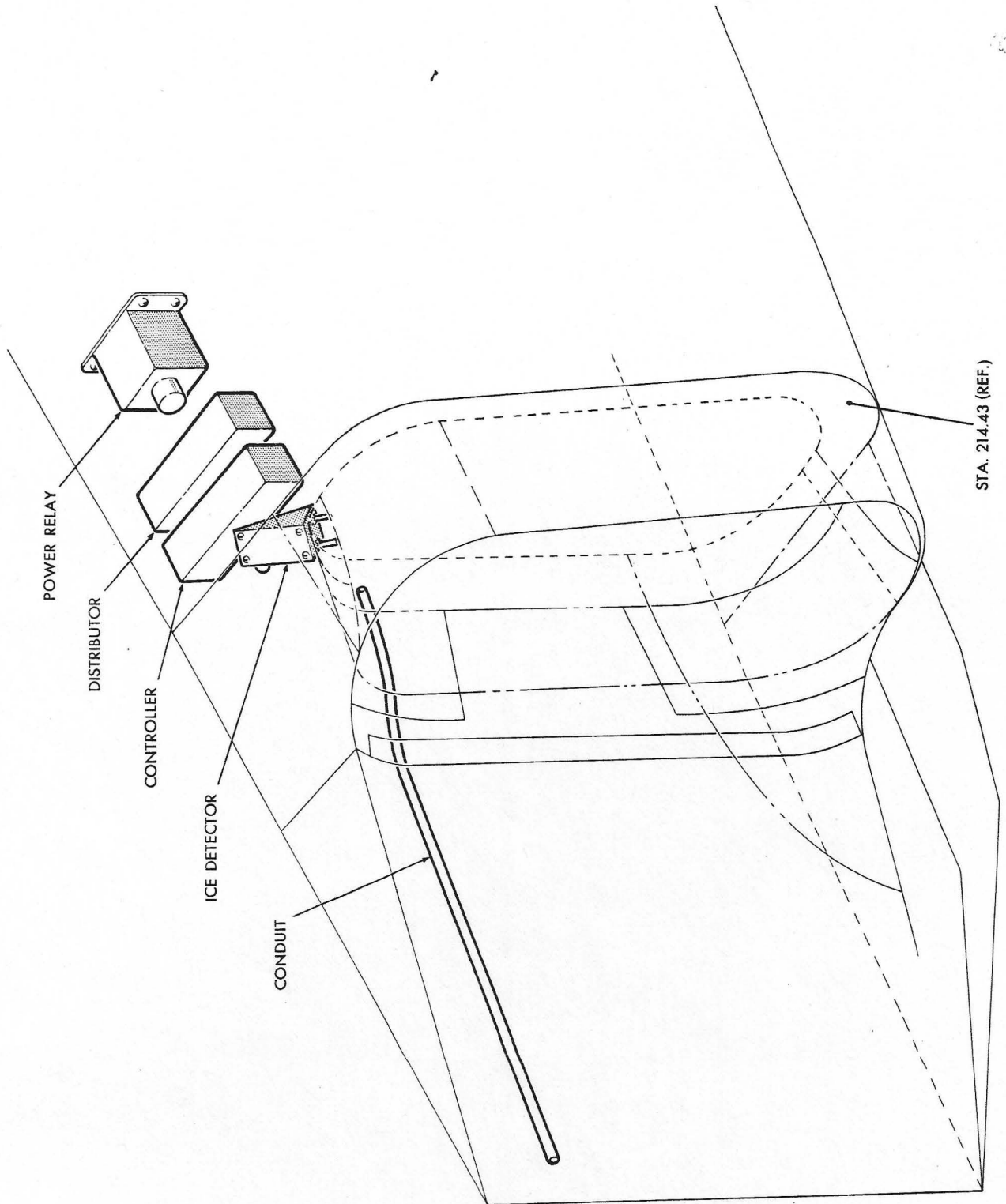
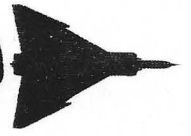

MAY/57

FIG. 2 DE-ICING EQUIPMENT

/51



2933-109-1

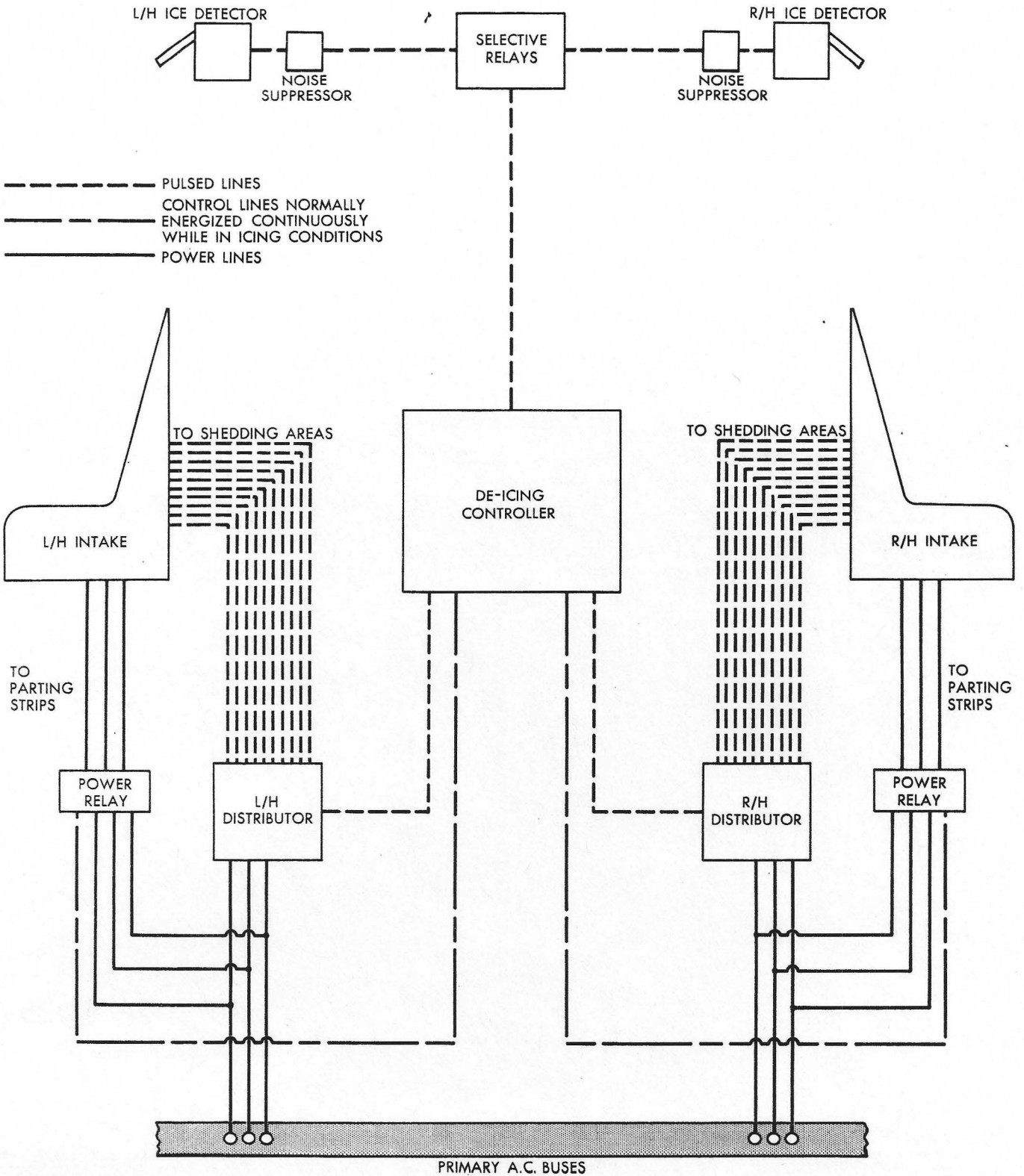

MAY/57

FIG. 3 BLOCK DIAGRAM OF INTAKE DE-ICING

/51



2534-105-1

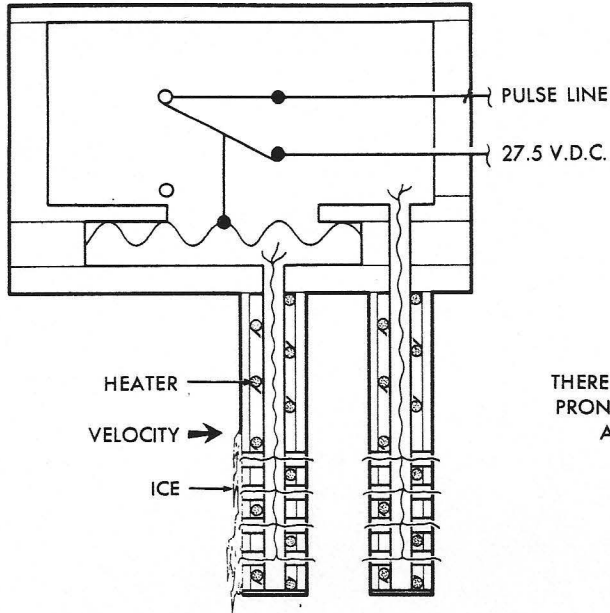

THERE ARE ONLY TWO PRONGS AND THESE ARE IN LINE

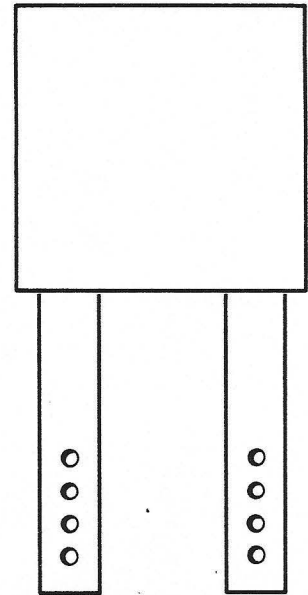

TRUE VIEW

VIEW WITH ONE PRONG MOVED OUT FROM CORRECT POSITION TO SHOW FUNCTION OF SWITCH

ICE DETECTOR IN ICED CONDITION

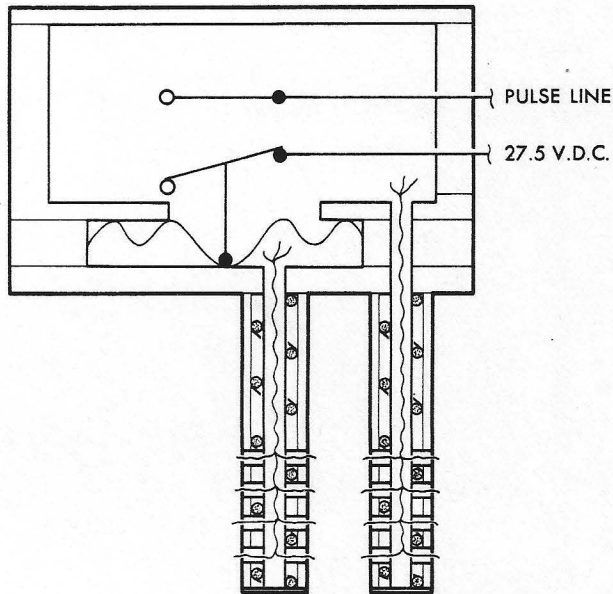

DIAGRAMMATIC VIEW (SEE NOTE ABOVE)

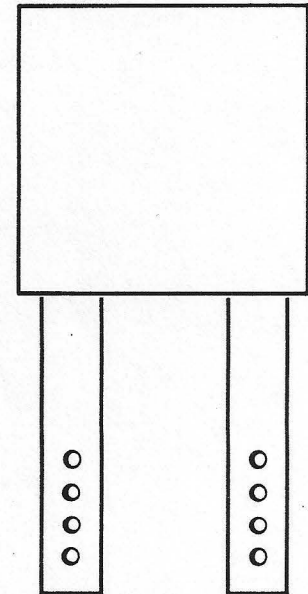

TRUE VIEW

ICE DETECTOR IN DE-ICED CONDITION

2525-109-1

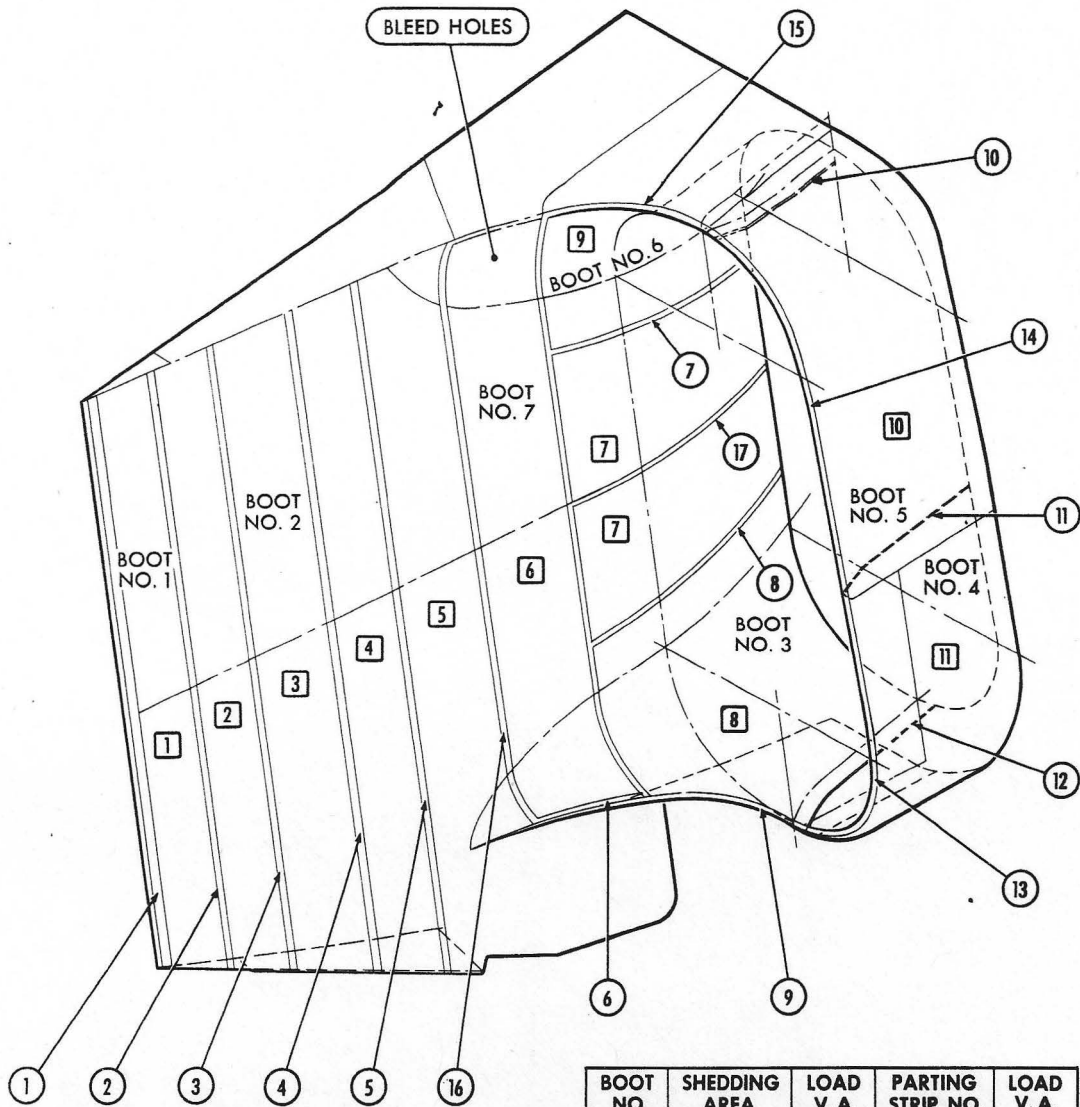

BOOT NO.	SHEDDING AREA	LOAD V. A.	PARTING STRIP NO.	LOAD V. A.
1	1*	1670	1	480
2	2 }	3280	2	122
	3	4950	3	388
	4	4950	4	140
	5	4950	5	148
	6		6	95
			16	375
3	7+	2550	8	123
	8	4950	9	232
			12	100
			17	47
4	11	4950	11	100
			13	300
5	10	4950	10	100
			14	300
6	7+	2400	7	123
			9	232
7	6	4950		
			TOTAL	8355

LEGEND	
□	SHEDDING AREAS
○	PARTING STRIPS
+ }	CYCLED TOGETHER AS ONE SHEDDING AREA
* }	

MAY/57

FIG. 5 DUCT DE-ICING

/51

2334-109-1

MAY/57

FIG. 6 BOOT CONSTRUCTION AND INSTALLATION OF OVER-HEAT SWITCH

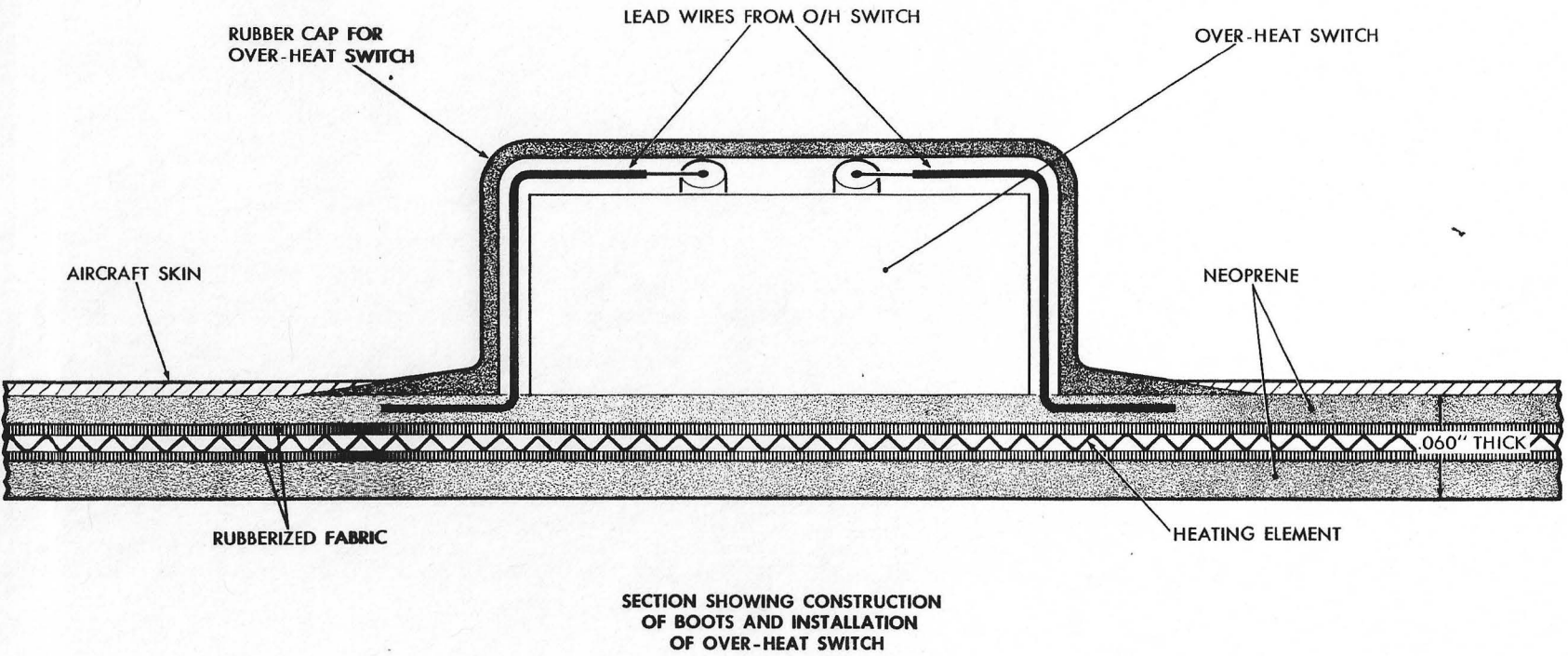

/51

MAY/57

FIG. 7 RADOME DE-ICING SYSTEM

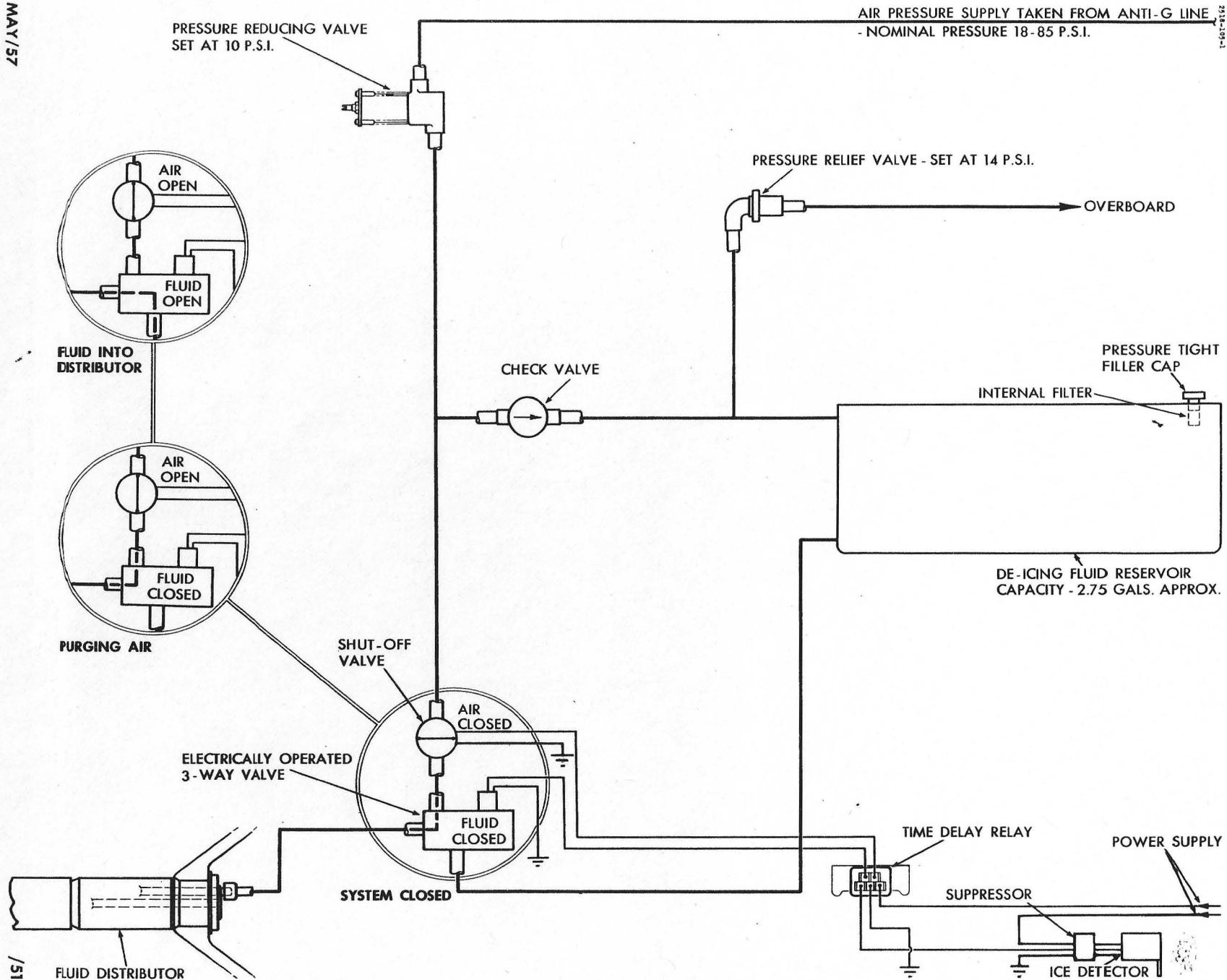

AVRO AIRCRAFT LIMITED

UNCLASSIFIED  
CONFIDENTIAL

UNCLASSIFIED

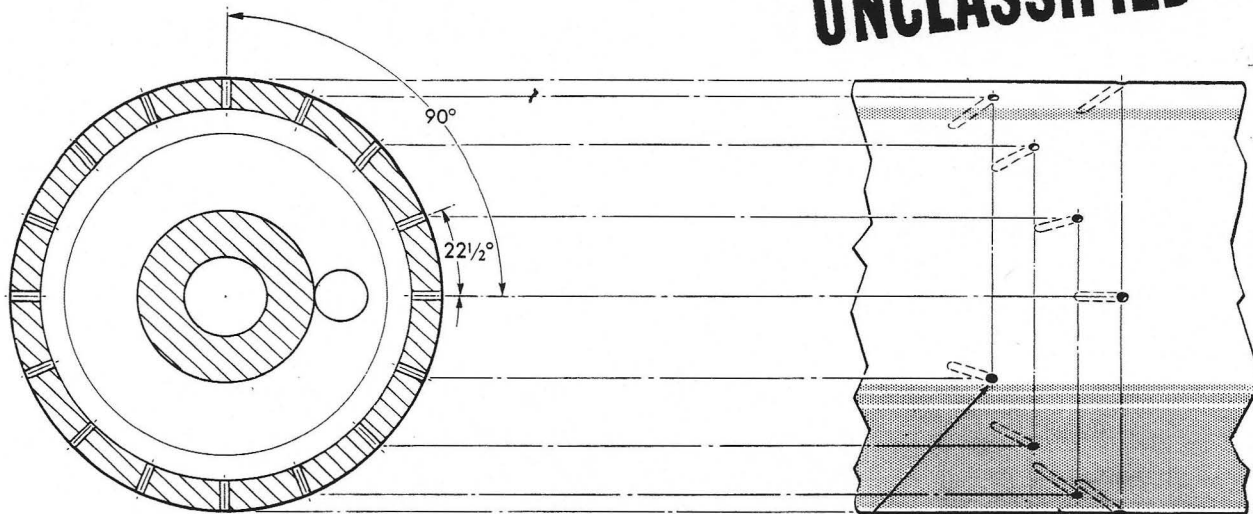

16 HOLES .020 DIA.  
IN ROWS OF FOUR  
AS SHOWN

2 PART VIEWS SHOWING POSITIONS OF HOLES

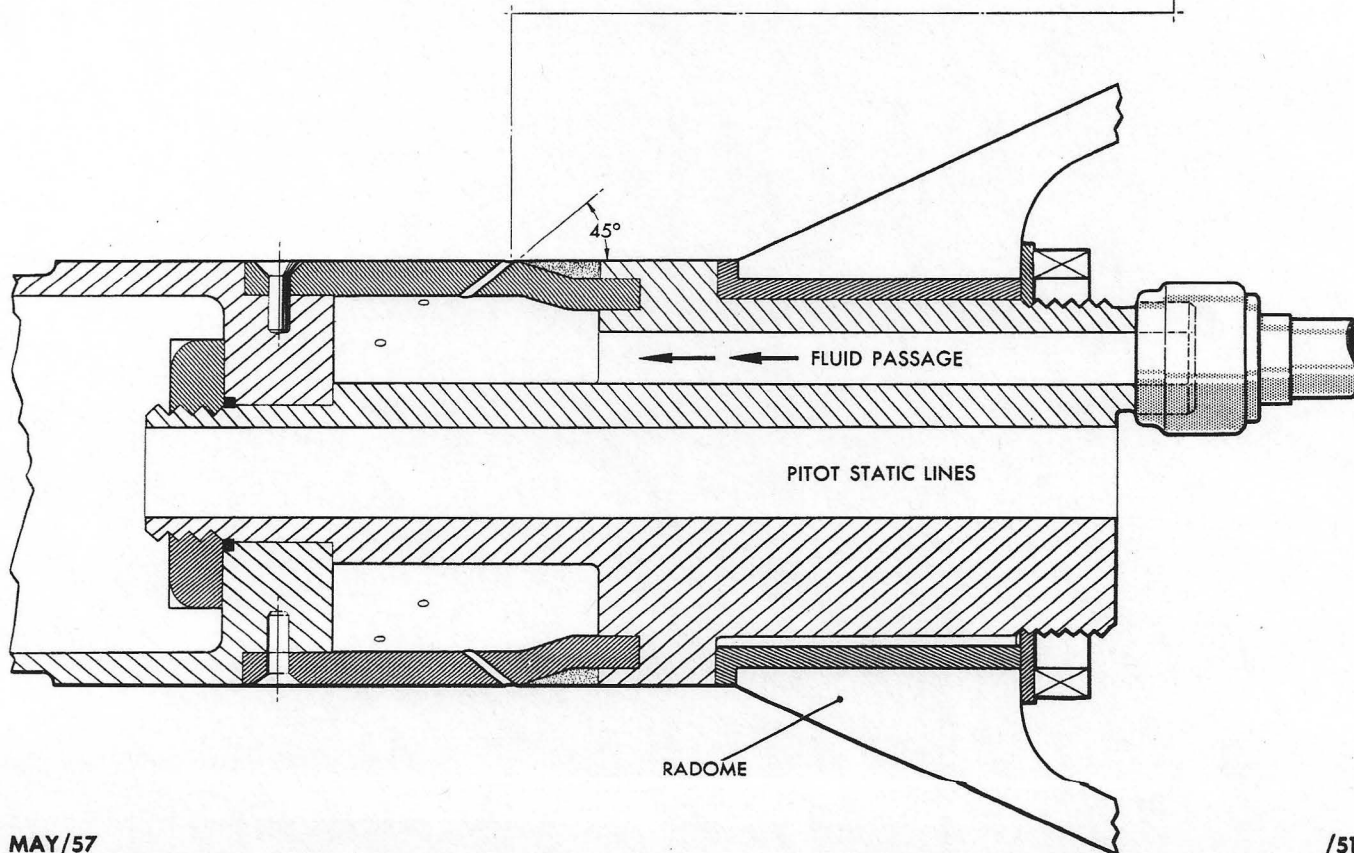

MAY/57

/51

FIG. 8 RADOME FLUID DISTRIBUTOR