

new 1952

Buccanner
OUTBOARD MOTORS

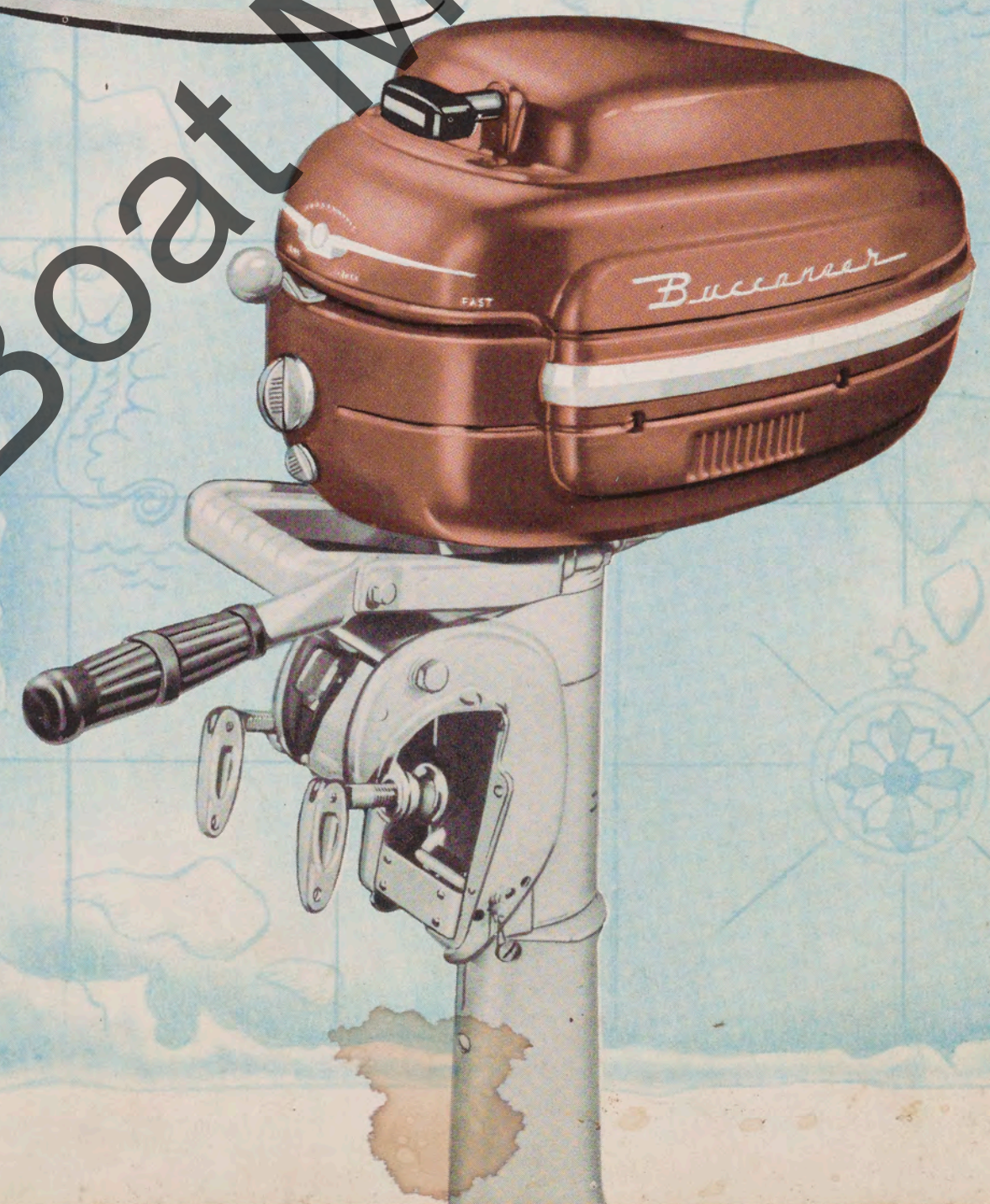

Antique Boat Museum

THE HIT OF THE YEAR —

Buccaneer



BUCCANEER
your "buy" word for

★ **OUTSTANDING PERFORMANCE**

★ **QUICKER STARTING**

★ **ECONOMICAL**

★ **ALL ROUND SATISFACTION**

Your Best Horsepower-Per-Dollar Buy on the Market!

3 H. P. STANDARD

- Dura-Life Magneto • Full 360° Pivot
- Adjustable Co-Pilot • Handy Fuel Shut-Off
- Cock • Single Cylinder • Bore and Stroke 2½ x 1½ • Piston Displacement 5.32 Cu. In. • Rubber Rotor Positive Displacement Water Pump • Fresh Water Flush Plug • 2-Blade Weedless Propeller With Shearpin • Synchronized Single Lever Spark and Throttle Control • Weight, 28 lbs. Recommended Transom Height 15" • Salt Water Protected • Mounted in Rubber to Reduce Vibration • 13:22 Gear Ratio • Variable Venturi Carburetor • Fuel Tank Capacity 0.5 Gals. • Running Time (full throttle) 1¾ Hrs.

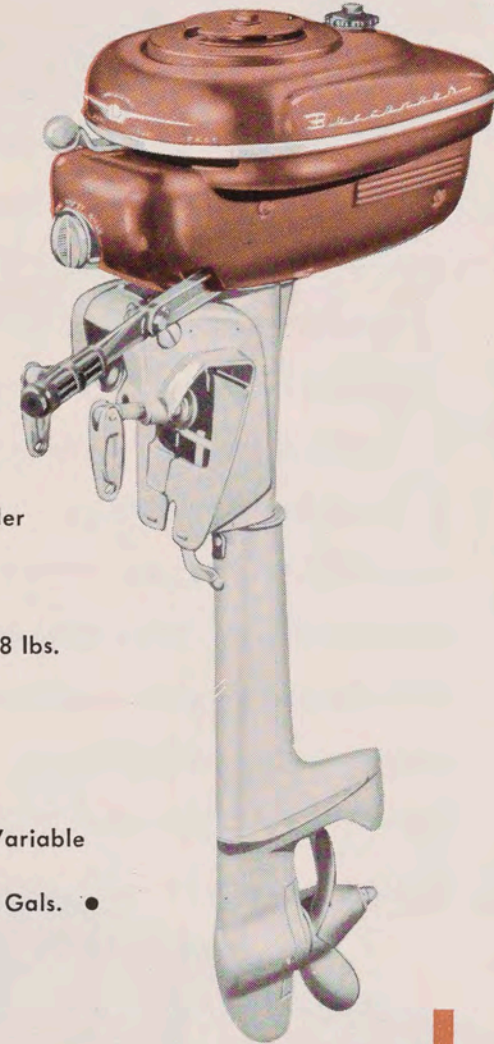

Light Weight Single

This light weight Buccaneer is streamlined and compact, simple to handle, easy to tuck away in your car trunk... yet it's packed with power. A favorite with women and children because it is not complicated in operation. Fishermen like it, too, because it is sufficiently sturdy to suit their needs. QUICK STARTING. Has many features of larger Buccaneer models. Scientifically engineered to meet every Buccaneer quality standard, it's a stand-out in the low-priced field. THE HIT OF THE YEAR — THAT'S BUCCANEER.

3 H. P. DE LUXE

- AUTOMATIC REWIND STARTER • Dura-Life Magneto • Full 360° Pivot
- Adjustable Co-Pilot • Handy Fuel Shut-Off Cock • Single Cylinder • Bore and Stroke 2½ x 1½ • Piston Displacement 5.32 Cu. In. • Rubber Rotor Positive Displacement Water Pump • Fresh Water Flush Plug • 2-Blade Weedless Propeller With Shearpin • Synchronized Single Lever Spark and Throttle Control • Weight, 29 lbs. • Recommended Transom Height 15" • Salt Water Protected • Mounted in Rubber to Reduce Vibration • 13:22 Gear Ratio • Variable Venturi Carburetor • Fuel Tank Capacity 0.5 Gals. • Running Time (full throttle) 1¾ Hrs.



Automatic Rewind Starter

Here it is, fishermen! A Buccaneer you'll be proud to own. Its Automatic Rewind Starter and streamlined housings are modern, de luxe features which you can enjoy without spending a fortune. Light in weight, easy to handle, yet it's packed with the power punch every fisherman wants. You can depend on it for QUICK STARTING, for years of trouble-free service, for day-after-day dependability the year 'round. Tops in performance, it's always rarin' to go when you are. Dollar for dollar it's one of the nation's outstanding buys in outboard motors. THE HIT OF THE YEAR — THAT'S BUCCANEER.

5 H. P. STANDARD

- Dura-Life Magneto • Automatic Rewind Starter • Full 360° Pivot • Adjustable Co-Pilot • Alternate Firing Twin • Handy Fuel Shut-Off Cock • Bore and Stroke 1-15/16 x 1½ • Piston Displacement 8.84 Cu. In. • Fuel Tank Capacity 0.8 Gals. • Running Time (full throttle) 1 Hr. • 1½ to 12 MPH, Light to Heavy Boats • Rubber Rotor Positive Displacement Water Pump • Fresh Water Flush Plug • 2-Blade Weedless Propeller with Rubber-Cushioned Shock Absorber • Synchronized Single Lever Spark and Throttle Control • Weight, 45 lbs. • Recommended Transom Height 15" • Salt Water Protected • Mounted in Rubber to Reduce Vibration • Gear Ratio 13:20 • Single Jet Variable Venturi Carburetor



Alternate Firing Twin

This Buccaneer "five" is popular among sportsmen who want speed and power combined with quiet, smooth trolling. A QUICK STARTING, rugged outboard motor that gets you out to your favorite fishing spots in a jiffy and brings you back on schedule. Sputter-free performance, automatic rewind starter, full 360° reverse, extra large fuel tank capacity and rubber propeller cushion are just a few of the many features which make this Buccaneer first choice among thousands of fishermen. Compare its quality points, dollar for dollar. You'll discover that... THE HIT OF THE YEAR — THAT'S BUCCANEER.

12 H. P. STANDARD

- Dura-Life Magneto • Automatic Rewind Starter • Adjustable Co-Pilot • Alternate Firing Twin • Handy Fuel Shut-Off Cock • Bore and Stroke 2¾ x 2¼ • Piston Displacement 19.94 Cu. In. • Fuel Tank Capacity 1.5 Gals. • Running Time (full throttle) ¾ Hrs. • 2 to 22 MPH, Light and Heavy Boats • Rubber Rotor Positive Displacement Water Pump • Fresh Water Flush Plug • 2-Blade Weedless Propeller with Rubber Cushioned Shock Absorber • Synchronized Single Lever Spark and Throttle Control • Light Weight, 66 Lbs. • Recommended Transom Height 15" • Salt Water Protected • Mounted in Rubber to Reduce Vibration • Gear Ratio 13:19 • Automotive Type Carburetor

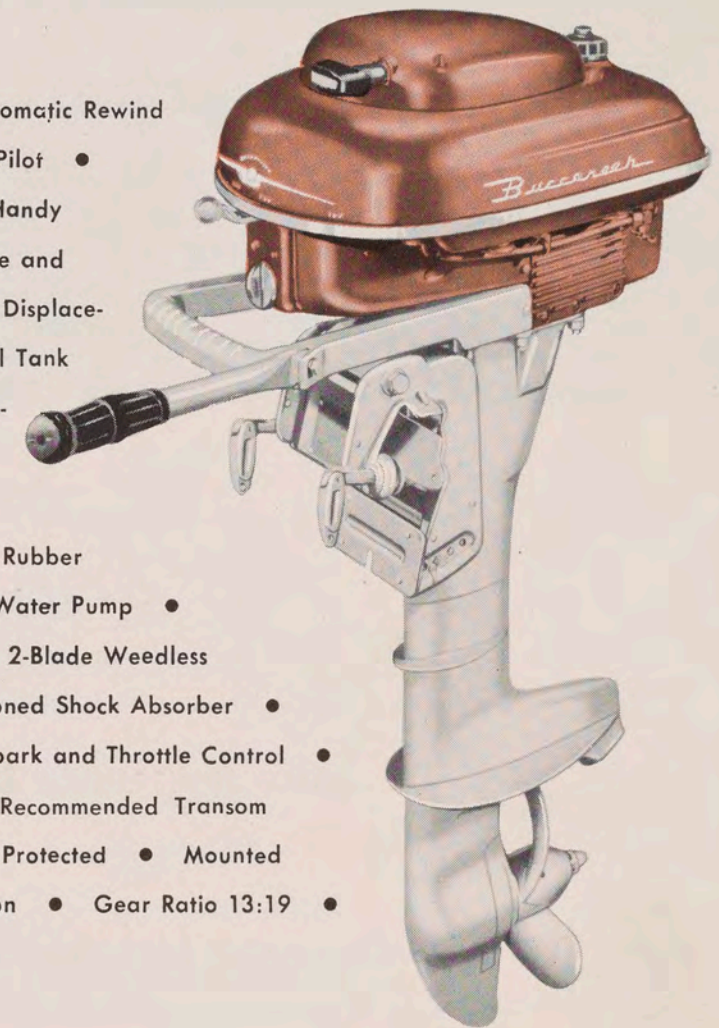

Power-Packed Twin

For the sportsman who wants trigger acceleration powerful drive this Buccaneer is just the "ticket." It's husky, rugged, packed with power, speed and zing... yet when it's idling, or throttled down for trolling it's as quiet as a mill pond. QUICK EASY STARTING and unusually stable steering make this one of the safest large motors to handle at fast speeds. No wonder this "Twelve" is one of Buccaneer's best-selling models! It has so many outstanding quality features that you would expect it to cost more than it does. It's a Buccaneer value worth comparing. Comparison will prove that, dollar for dollar, it's your best buy. THE HIT OF THE YEAR — THAT'S BUCCANEER.

ALL HORSEPOWER RATINGS CERTIFIED

BY
OUTBOARD BOATING CLUB OF AMERICA



Feel the Surge of Power!

Know the Satisfaction of Quick Starting, the Thrill of Adventure . . . Buy Buccaneer — Your "Treasure Chest" of Outdoor Fun!

Heigh, Ho, mates! Whether you're slipping away from the dock in the cool, gray dawn, trolling quietly along the edge of the lily pads at eventide, or whether you're slicing through the rippling green water on a lazy Sunday afternoon — Buccaneer's your "buddy" . . . your pal and companion . . . your "Good Man Friday!"

Buccaneer won't let you down, no matter which model you choose. They're all as staunch, as rugged, as rough-and-ready, as any buccaneer who ever wielded a cutlass.

Any Buccaneer is rarin' to go when you are. Ready to match your love of fun and the outdoors, your spirit of adventure.

For your "Pieces of Eight" Buccaneer is your best "buy" word. Streamlined in design, modern in principle, precision engineered, Buccaneer brings you a brand new conception of outboard motor performance and efficiency in its 1951 models.

For the time of your life for a lifetime — buy Buccaneer, the greatest horsepower-per-dollar value on the market!
THE HIT OF THE YEAR — THAT'S BUCCANEER.

Litho in U. S. A.

GALE PRODUCTS



Galesburg, Illinois

THE HIT OF THE YEAR — *Buccaneer*

Flexi-Clutch — A shock absorbent protection slip clutch inside the gear case is lubricated by automotive hypoid oil. It does efficiently the job that other so-called clutches are supposed to do. It also gives you the added advantage of being able to operate motor in neutral. The neutral feature of Flexi-Clutch is operated by a lever on the side of the motor, which controls operation of motor in either neutral or drive.

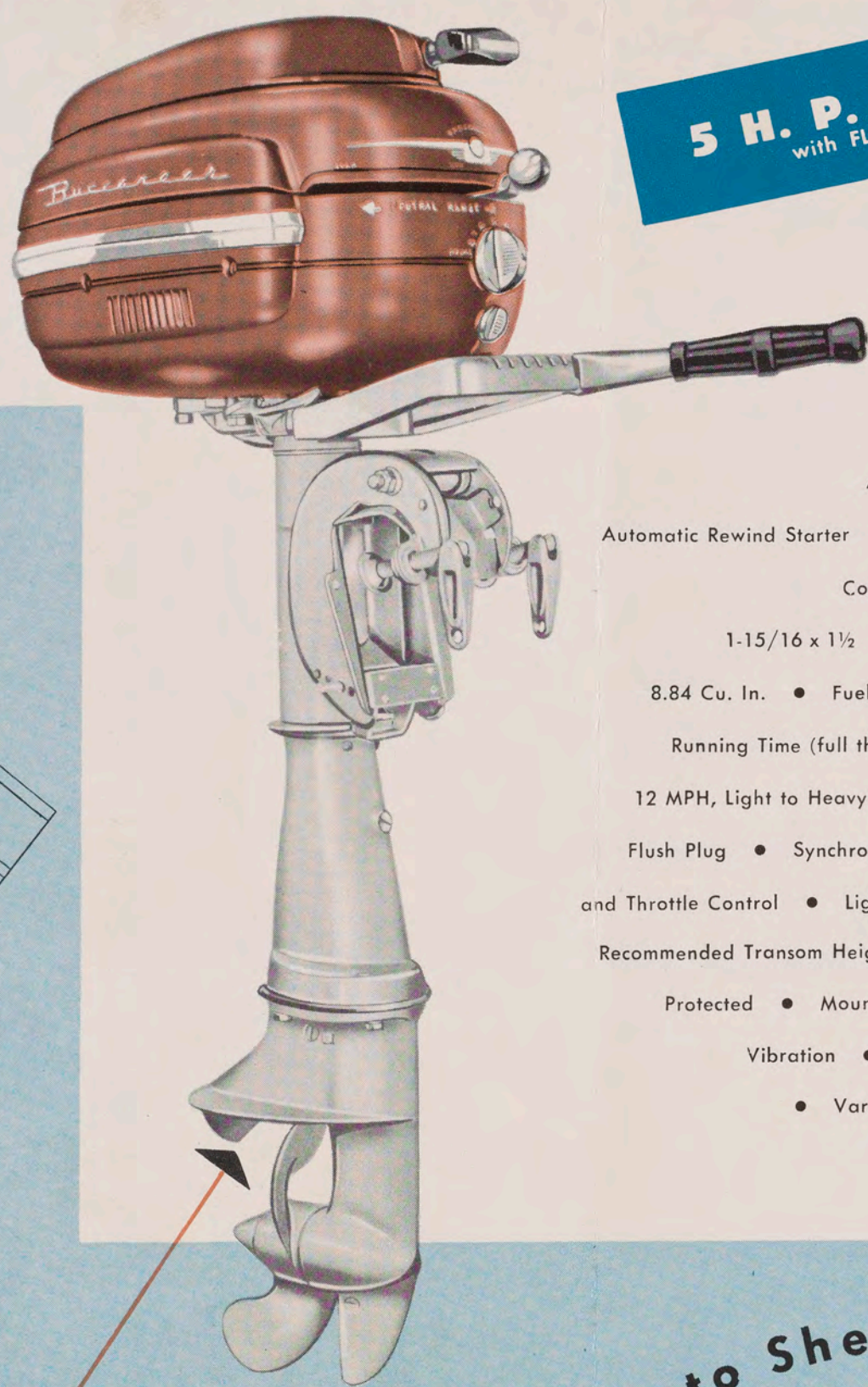
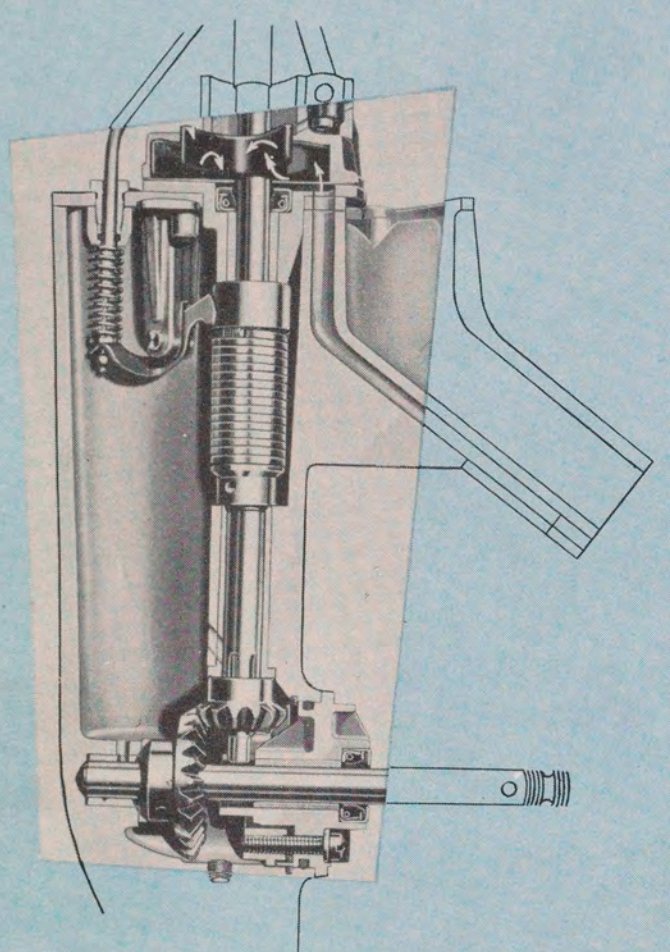

5 H. P. DE LUXE
with FLEXI CLUTCH

Flexi-Clutch • Neutral

- Equi-Flow Water Pump
- Dura-Life Magneto
- Full 360° Pivot
- Adjustable Co-Pilot
- Alternate Firing Twin
- Automatic Rewind Starter
- Handy Fuel Shut-Off Cock
- Bore and Stroke 1-15/16 x 1 1/2
- Piston Displacement 8.84 Cu. In.
- Fuel Tank Capacity 0.8 Gals.
- Running Time (full throttle) 1 Hr.
- 12 MPH, Light to Heavy Boats
- Fresh Water Flush Plug
- Synchronized Single Lever Spark and Throttle Control
- Light Weight, 46 1/2 Lbs.
- Recommended Transom Height 15"
- Salt Water Protected
- Mounted in Rubber to Reduce Vibration
- Gear Ratio 14:25
- Variable Venturi Carburetor

Buccaneer's Flexi-Clutch makes shifting a cinch. Start your engine in neutral, flip a lever on the side of the motor and away you go quicker than you can say Jack Robinson! And you can safely shift into forward, or neutral within the shifting range, giving you greater maneuverability, closer control of your boat and motor at all times.

The full 360° reverse and Flexiclutch make it easy for you to back in and out of tight spots. You can shift to neutral to land a fish, then shift into forward and continue trolling. If you snag your line you can stop or even back away until your line is free.

Flexiclutch is just one of the many quality features of this great Buccaneer model. Check the others listed at your left. Compare these features with other outboard motors in this price class. When you boil down all the facts you'll find that Buccaneer is your best horse-power-per-dollar buy in the outboard field.

Here again is proof that...THE HIT OF THE YEAR — THAT'S BUCCANEER.

Now! Say Goodbye to Shear Pins!

You can throw 'em away, mister. The 5 H.P. DE LUXE Buccaneer makes shear pins as old fashioned as the moustache curl! Flexi-Clutch is the modern answer to the shear pin problem. No more awkward pin changing. The old style shear pin has been replaced by a Monel metal drive pin. You can go over rocks, oyster beds, sand bars and strike submerged objects with nary a worry — Flexi-Clutch absorbs the shock automatically. Another reason why... THE HIT OF THE YEAR — THAT'S BUCCANEER.



Equi-Flow Rubber Blade Water Pump — A Buccaneer feature which assures an ample supply of cooling water at all speeds, including neutral. It will outwear other types of pumps but should wear occur replacement parts are inexpensive.

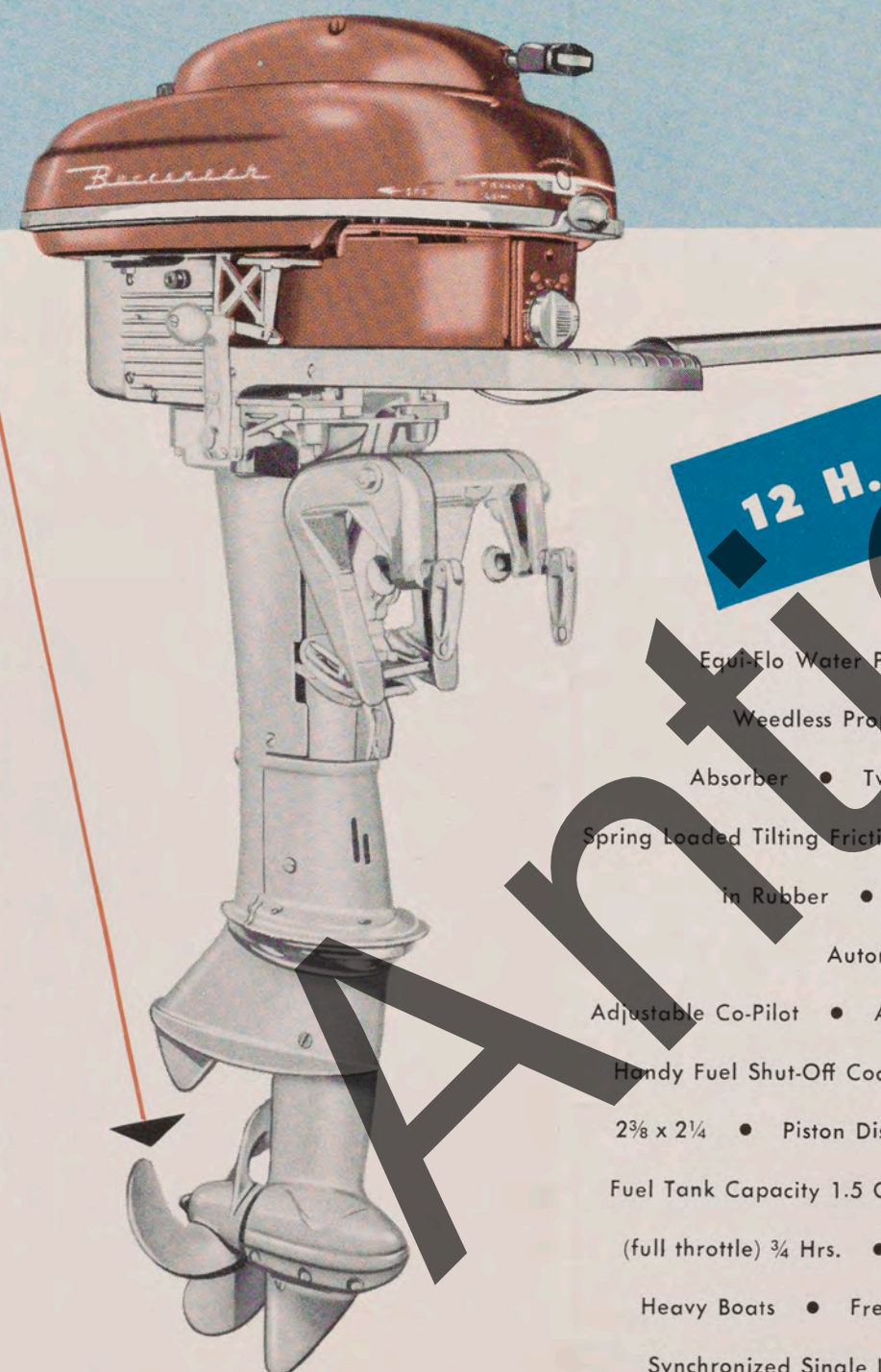
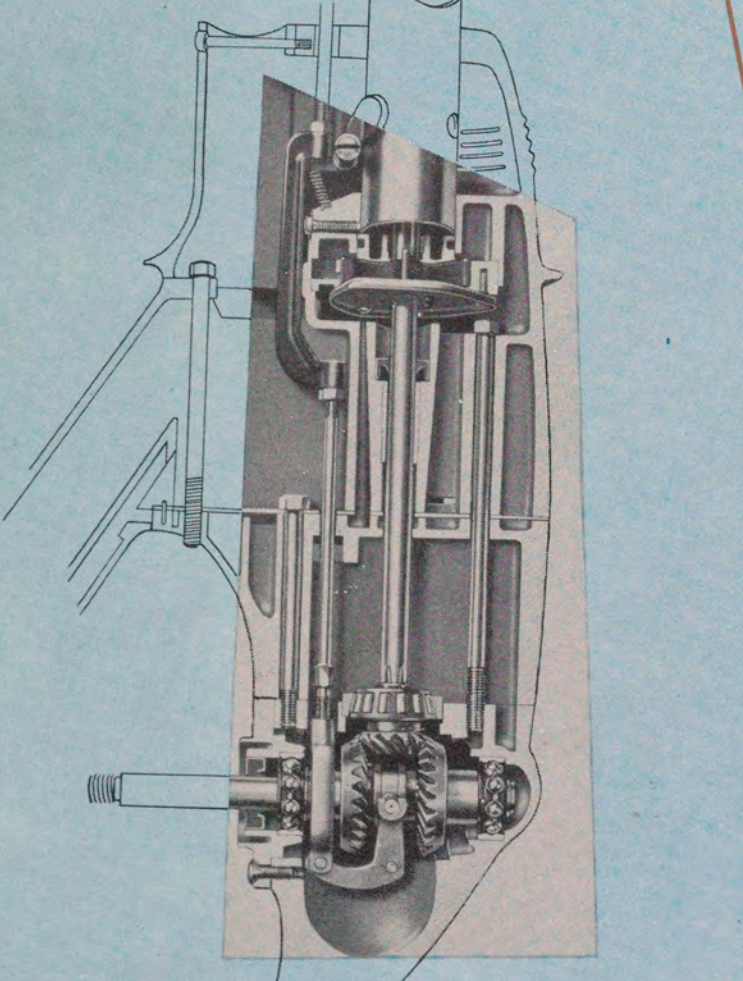

12 H. P. DE LUXE
with GEARSHIFT

Gear Shift (Neutral, Forward, Reverse)

- Equi-Flow Water Pump
- 3-Blade Semi-Weedless Propeller with Rubber Shock Absorber
- Twist-Grip Throttle Control
- Spring Loaded Tilting Friction
- Motor Mounted in Rubber
- Dura-Life Magneto
- Automatic Rewind Starter
- Adjustable Co-Pilot
- Alternate Firing Twin
- Handy Fuel Shut-Off Cock
- Bore and Stroke 2 3/8 x 2 1/4
- Piston Displacement 19.94 Cu. In.
- Fuel Tank Capacity 1.5 Gals.
- Running Time (full throttle) 3/4 Hrs.
- 2 to 22 MPH, Light to Heavy Boats
- Fresh Water Flush Plug
- Synchronized Single Lever Spark and Throttle Control
- Light Weight, 64 1/2 Lbs.
- Recommended Transom Height 15"
- Salt Water Protected
- Gear Ratio 12:21
- Automotive Type Carburetor

Here is the last word in Buccaneer Outboard Motors — the "Ace" of them all. Shifting is made simple, easy, quick with the Gearshift feature. Just grasp the lever on the side of the motor... immediately you have the position you want — forward, reverse or neutral. An automatic control prevents shifting at speeds which might be dangerous to both you and your boat. Buccaneer's Gearshift makes getting out of tight spots easy and docking is "duck soup."

Built-in rubber shock absorber in the 3-blade semi-weedless propeller provides added protection to both propeller and gears. The power head is mounted in rubber for quiet, smooth operation; there is practically no vibration in steering handle. The Equi-Flow rubber blade water pump assures an ample supply of cooling water at all speeds. The twist grip throttle control gives you better command of your boat and motor.

These features, plus many other latest improvements, make the Buccaneer "Twelve" De Luxe the last word in outboard motors. Buy it and you get the best. THE HIT OF THE YEAR — THAT'S BUCCANEER.

Gearshift — With this outstanding Buccaneer convenience you can quickly and easily shift into neutral, forward or reverse. Shifting is accomplished by means of a lever located on the side of the motor.



Compare These Outstanding Buccaneer Features

Dura-Life Magneto — Provides hotter, stronger spark and quicker, easier starting. New special process plastic moulded coil makes magneto virtually waterproof. Reliable automotive type rocker arm and breaker point assembly is easier to get at for cleaning and adjusting.

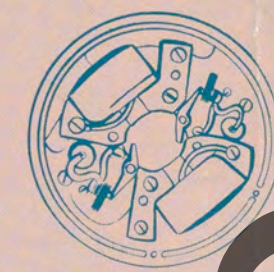

360° Pivot (on 3 H.P. and 5 H.P. models) — Full reverse. Greater maneuverability. Swivels completely around or in any direction. Gives you better control over boat and motor. Locks automatically when in reverse.

Automatic Rewind Starter — Simple in design and operation, yet durable and dependable. Instant engagement and release. No complicated gadgets to give trouble. Simple, easy to clean. Starter cord extra long to prevent pulling out.

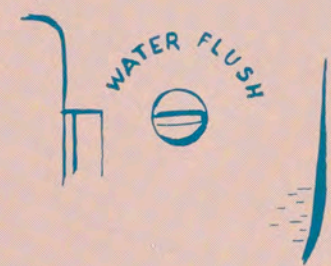
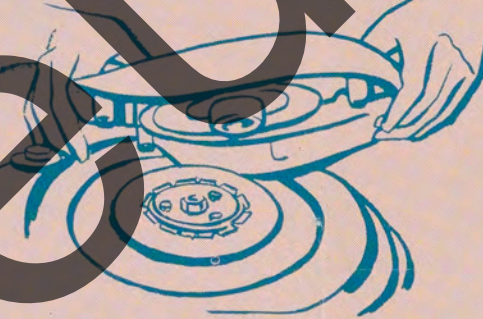

Flush Plug — Fresh water plug in lower unit for flushing out motor after use in salt water. Motor stays cleaner, lasts longer, runs cooler if flushed out with fresh water after each time it is used in salt water. Handy, easy to get at and flush.

Balanced Flywheel — Buccaneer flywheels are individually balanced to insure vibration-free operation, smoother and more efficient performance.

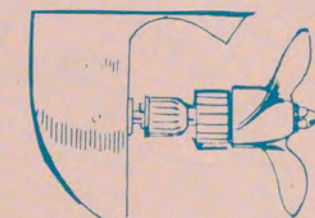
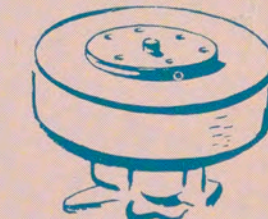

Rubber Cushioned Propeller (on 5 H.P. Standard, 12 H.P. Standard and 12 H.P. De Luxe Models) — Propeller cushioned in rubber to absorb shock when it hits underwater objects.

Alternate Firing Twin — Smooth flow of power for speed or idling. Less vibration, more economy. Easier starting, better trolling, quicker acceleration, longer life. Pistons and connecting rods of aluminum alloy. Finest quality bronze alloy bearings bored to precision standards.

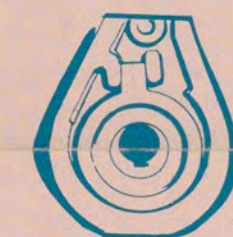
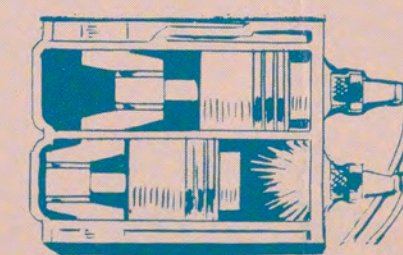

Rubber Rotor Water Pump (on all models except De Luxe 5 H.P. and De Luxe 12 H.P.) — Simplified design and quality materials assure longer life and trouble-free operation. Positive displacement type which assures ample supply of water at all speeds.

Single Jet Carburetor (on 3 H.P. and 5 H.P. models) — Easy to adjust, simple to maintain. Float feed type with low speed idling adjustment gives better performance throughout full range of throttling. No complicated adjustments to make when changing speeds. Improved needle valve packing means leak-proof operation.

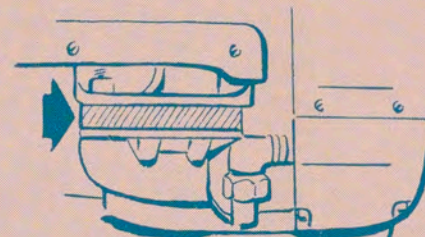
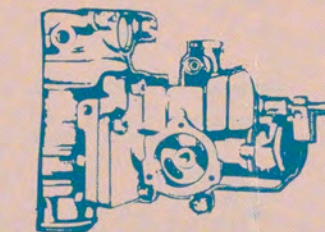

Rubber Cushion Mountings (on all models, illustration shows type used on 12 H.P. De Luxe) — Rubber insulated against vibration. Greater ease of steering, smoother running, quieter operation.

- automatic co-pilot
- twist-grip aluminum throttle
- polished aluminum speed control lever
- polished aluminum carburetor control
- metal fuel tank filler cap

for the time of your life for a lifetime-buy *Buccaneer*

