

General
Instruction Book

for

1937

JOHNSON *SeaHorse*
OUTBOARD MOTORS



JOHNSON MOTORS
WAUKEGAN, ILLINOIS

Part No. 13-640

N.S.P. 1-37-19M

JOHNSON SERVICE

It has always been the belief of Johnson Motors that a sale does not complete the transaction between the manufacturer and the buyer. It establishes, rather, a new obligation—an obligation whereby Johnson Motors agrees to assist the buyer in obtaining utmost service from a Johnson Outboard Motor.

With this policy ever uppermost in our minds, we have built up an organization that consists of a nation-wide network of Johnson Service Stations to give prompt and efficient service to owners of Johnson Outboard Motors. Pages 44, 45 and 46.

The first step in this structure is the local Johnson Dealer, who is supplied with first-aid parts, enabling him to make emergency and minor repairs. Second, the Authorized Service Station, which carries a stock of parts and equipment necessary to properly service Johnson Outboard Motors. Third is the District Service Station, with a complete stock of parts for all models, tool equipment and factory trained mechanics capable of making extensive repairs. In addition, Johnson Motors maintain a complete Service Department at the factory to extend, further, this Service to the Johnson Outboard Motor owner.

It has, therefore, been our endeavor to place a Service Station within easy reach of every Johnson Outboard Motor owner and to cooperate in lending our assistance whenever possible.

JOHNSON MOTORS

WAUKEGAN, ILLINOIS

WARRANTY

We warrant each new outboard motor of our manufacture to be free from defects in material and workmanship under normal use and service, our obligation under this warranty being limited to making good at the factory any part or parts thereof which shall, within three (3) months after delivery of such motor to original purchaser, be returned to us with transportation charges prepaid, and which our examination shall disclose to our satisfaction to have been thus defective; this warranty being expressly in lieu of all other warranties and representations expressed or implied and of all other liabilities in connection with the sale or use of any motors.

This warranty shall not apply to any motor which shall have been repaired or altered outside the factory in any way so as to affect its stability, nor which has been subject to misuse, negligence or accident.

We make no warranty in respect to trade accessories not of our manufacture, inasmuch as they are usually warranted separately by their respective manufacturers.

Because of the usual strains and accidents to which such products may be subjected, we make no warranty of either material or workmanship in racing outboard motors or any of our products when used for racing.

Claims must be entered on motors or motor parts returned to the factory for inspection, repair or replacement. Request form No. SE-16 from local Johnson Dealer or Service Station. This form should be filled in, signed by the motor owner and dealer or service station representatives and mailed to the factory with returned material, TRANSPORTATION CHARGES PREPAID.

Foreword

This instruction booklet is not a service manual, but a booklet prepared for the purpose of conveying to the Johnson Motor Owner, such information as will enable him to thoroughly understand the operation of his motor and the necessary procedure for its proper maintenance.

Dependability and long life are built into every Johnson Outboard Motor shipped from our factory—this is OUR RESPONSIBILITY. You will no doubt want to take full advantage of these valuable features and to enjoy hour after hour—year after year, that Dependability which can be realized only if the motor is properly cared for—That is YOUR responsibility.

The instructions contained in this booklet are essential and, if closely adhered to, will assist in obtaining the utmost from your Johnson Outboard Motor.

Don't Fail to Register Your Motor

Your motor is known to the factory only by its MODEL and SERIAL NUMBER. This number is located on the top of the flywheel as shown in Fig. 1—on all models except the DeLuxe Single and DeLuxe Twin, where it will be found stamped on the gas tank.



Fig. 1. Name plate, showing model and serial number.

Always give the serial number and model when seeking information or ordering parts.

For assistance in case of theft, you should register the serial number of your motor by filling out and returning the registration card, enclosed in the tool kit, to the factory.

Mechanical Specifications	Sea-Horse 110	Sea-Horse 210	Sea-Horse LS	Sea-Horse DS	Sea-Horse DT	Sea-Horse AA	Sea-Horse KA	Sea-Horse PO
POWER-HEAD								
Bore and Stroke	2" x 1 1/2"	2" x 1 1/2"	1 7/8" x 1 1/2"	1 7/8" x 1 1/2"	1 7/8" x 1 1/2"	1 7/8" x 1 1/2"	2 1/8" x 1 31/32"	2 3/4" x 2.52"
No. of Cylinders	1	2	1	1	2	2	2	2
N.O.A. Certified Brake H.P.	1.7 at 3300	3.3 at 3000	2.1 at 4000	2.1 at 4000	4.2 at 4000	4.5 at 4000	9.3 at 4000	22. at 4000
R.P.M.	4.71 Cu. In.	9.4 Cu. In.	4.14 Cu. In.	4.14 Cu. In.	8.28 Cu. In.	8.28 Cu. In.	13.96 Cu. In.	29.92 Cu. In.
Piston Displacement	24 3/4 Lbs.	38 3/4 Lbs.	39 Lbs.	39 Lbs.	45 Lbs.	48 Lbs.	109 Lbs.	
Weight	7 3/8" x 4 1/2"	7 5/8" x 5 1/2"	8" x 4 3/4"	8" x 4 3/4"	8" x 7 1/2"	9 1/8" x 6"	9 1/8" x 6"	12" x 13"
Propeller Dia. Pitch	4 Pints	7 Pints	2 5/8 Pints	4 Pints	6 Pints	7 Pints	13 Pints	3 Blade
Fuel Tank Capacity	Rope	Rope	Rope	Ready Pull	Ready Pull	Rope	Rope	2 1/2 Gallons
Starting	Magneto	Magneto	Magneto	Magneto	Magneto	Magneto	Magneto	Magneto
Ignition	Own	Own	Own	Own	Own	Own	Own	Own
Make Carburetor	13-19	13-19	14-25	14-25	14-25	14-24	14-24	12-11
Gear Ratio	Underwater	Underwater	Underwater	Underwater	Underwater	Underwater	Underwater	Underwater
Type of Exhaust	Pressure Vacuum	Pressure Vacuum	Positive Plunger Pump	Positive Plunger Pump	Positive Plunger Pump	Pressure Vacuum	Pressure Vacuum	Pressure Vacuum
Cooling System	Pivot Steering	Pivot Steering	Full Pivot Cushioned	Full Pivot Cushioned	Full Pivot Cushioned	Full Pivot Rubber Mounted	Full Pivot Rubber Mounted	Pivot
Steering	No	No	Yes	Yes	Yes	Yes	Yes	No
Reverse	15"	15"	15"	15"	15"	14"	15 3/8"	16"
Stern Height (Max.)								

The Two Stroke Cycle

The two (stroke) cycle engine, such as used in all Johnson Outboard Motors, differs somewhat from the four (stroke) cycle engine used in your automobile, this difference being due to the method of conducting gases to and from the cylinder while in operation. The two (stroke) cycle engine employs an arrangement of ports rather than mechanically operated valves to accomplish this purpose, as shown in the following illustrations.

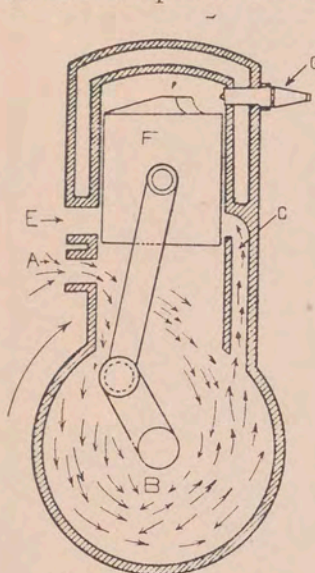

Illustration No. 1
On the first upward stroke of the piston, a partial vacuum or low pressure is created in the crankcase. As the piston progresses in its upward movement and nears the end of the stroke, intake port "A" is uncovered causing fuel vapor from the carburetor to flow into the crankcase—"B". The crankcase is now fully charged. (Three-port type.)

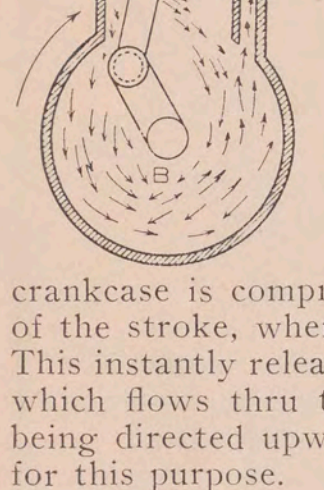

Illustration No. 2
The piston on reaching the end of the stroke reverses its direction and begins a downward movement—covering or closing intake port "A". On its continued downward movement, the vapor charge in the crankcase is compressed until the piston nears the end of the stroke, when the by-pass port "C" is uncovered. This instantly releases the compressed crankcase charge, which flows thru the by-pass and into cylinder "D"—being directed upward by the piston deflector provided for this purpose.

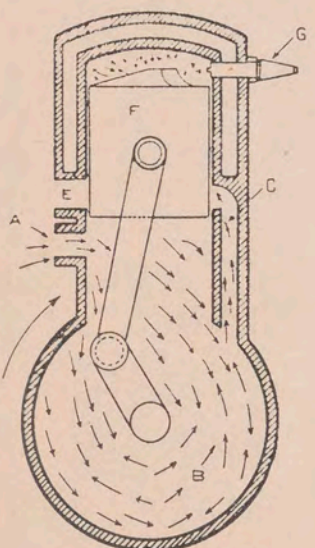

Illustration No. 3
On the following upward stroke, the vapor charge having been transferred to the cylinder is compressed and prepared for ignition. However, during this period a second charge has been drawn into the crankcase through intake port "A". There are now two charges—one compressed in cylinder "D" and the charge in the crankcase.

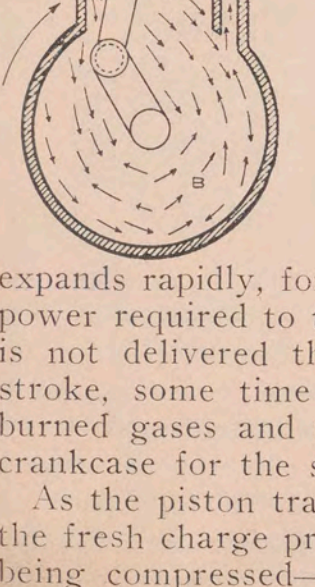

Illustration No. 4
At the end of the compression stroke, a spark, created by the magneto, jumps the gap between the points of spark plug "G"—igniting the compressed fuel vapor in cylinder "D". The vapor in burning expands rapidly, forces piston "F" downward to deliver power required to turn the propeller. Power, however, is not delivered throughout the entire length of the stroke, some time is required to rid the cylinder of burned gases and to receive a fresh charge from the crankcase for the succeeding power impulse.
As the piston travels downward on its power stroke, the fresh charge previously drawn into the crankcase is being compressed—Illustration No. 2.

Notice width of exhaust port "E" and by-pass port "C"—"E" is considerably wider than "C", therefore, piston "F" nearing the end of its stroke uncovers the exhaust port somewhat earlier than it uncovers the by-pass port.

A comparatively high pressure exists within the cylinder at this time, consequently, at partial uncovering of exhaust port "E", the burned gases commence to flow out through the exhaust port. Further travel of the piston uncovers by-pass port "C". The compressed vapor charge now in the crankcase is instantly released, flowing through the by-pass port into the cylinder and directed upward by the deflector. The incoming fresh charge continues to force the burned gases out of the cylinder through the exhaust port and into the atmosphere to complete the cycle.

UPWARD STROKE		DOWNWARD STROKE	
Compression	Takes Place in Cylinder	Power Exhaust Intake from Crankcase	
Admission of Fuel Vapor	Takes Place in Crankcase	Compression of Fuel Vapor Fuel Vapor Discharge into Cylinder	

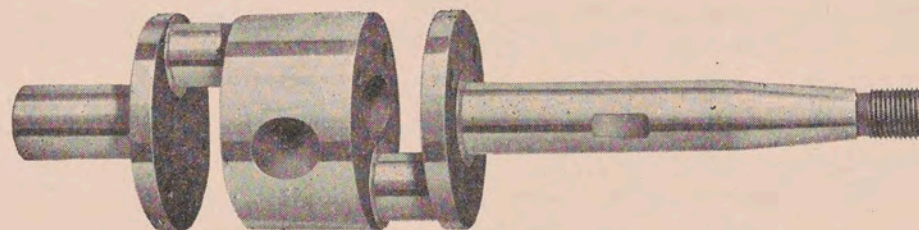

Fig. 2 Showing Crankshaft construction of Models AA and KA

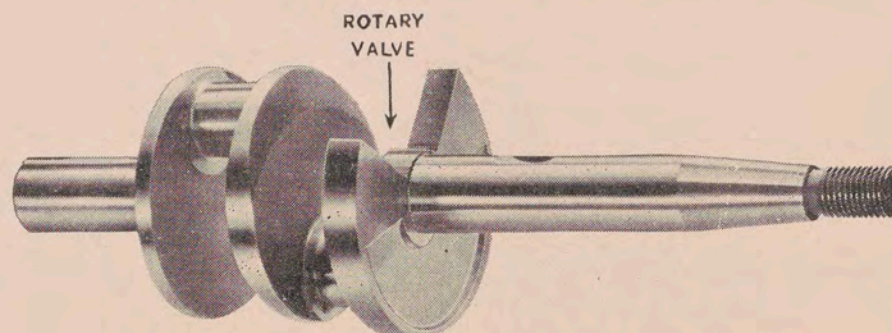

Fig. 3. Showing Crankshaft construction of Model PO

Models 110 and 210 are constructed with a third or intake port built into the cylinder wall and operated by the skirt of the piston, as shown in the foregoing illustrations. Model 110, however, has an additional port and by-pass built into the cylinder to insure efficient and smooth operation at slow trolling speeds.

Models AA, KA, alternate firing twins, and the PO operate on the same general principle, but the method of inducting the crankcase charge is somewhat different. The intake port, instead of being built into the cylinder wall is built into the crankcase and governed by a similar port or opening

machined into the circular throw of the crankshaft. This arrangement is known as the Rotary Valve. See Figs. 2 and 3.

Models LS, DS, LT and DT employ use of both the third port (built into the cylinder wall) and the Rotary Valve. By combining these features, it is possible to obtain highly efficient carburetion at all speeds. See page 30.

Fuel Mixture (Lubrication)

Since fuel vapors are first compressed in the crankcase of the engine, the most practical method of lubrication is by mixing the lubricating oil with the gasoline. Lubrication is obtained as the mixture of oil and gasoline enter the crankcase and is later transferred to the cylinders. Oil being less volatile than gasoline, a larger portion of the fuel-oil mixture remains in the crankcase to lubricate the bearings and other moving parts. The remainder enters the cylinder with the pre-compressed charge to aid in the lubrication of piston and piston rings.

It is extremely important that the oil, in the amounts specified, be thoroughly mixed with the gasoline to insure efficient operation of the motor. Use Mobiloil Marine Heavy Medium or Mobiloil "A" or an S.A.E. No. 30 oil of similar character and manufactured by a reputable concern.

To properly mix the oil and gasoline, they should be mixed in a separate container. (Such containers are illustrated in the Johnson Accessory Catalog. If you do not have one, write for it.) Never, except in an emergency, attempt to mix the oil and gasoline in the motor tank. It cannot be thoroughly mixed. Should the motor be started under such circumstances, it will operate for a short period on an intensely rich oil mixture, smoking profusely until the poorly mixed fuel is consumed. It will then continue to operate almost entirely on gasoline, with little or no lubrication; overheating, seizure and premature wear are the ultimate results.

Avoid expensive repairs—enjoy the qualities built into your motor by thoroughly mixing the oil and gasoline as instructed below:

Model	Oil Quantity	Capacity of Fuel Tank
110	½ Pint per Gal. of Gasoline	4 Pints
210	½ Pint per Gal. of Gasoline	6 Pints
LS	½ Pint per Gal. of Gasoline	2 5/8 Pints
DS	½ Pint per Gal. of Gasoline	4 Pints
LT	½ Pint per Gal. of Gasoline	5 Pints
DT	½ Pint per Gal. of Gasoline	5 Pints
AA	½ Pint per Gal. of Gasoline	7 Pints
KA	1 Pint per Gal. of Gasoline	13 Pints
PO	1 Pint per Gal. of Gasoline	2.4 Gallons

Use Mobiloil Marine Heavy Medium or Mobiloil "A" or an S.A.E. No. 30 oil of similar character and manufactured by a reputable concern. BE SURE IT IS THOROUGHLY MIXED.

(Note: The compression ratio of Johnson Outboard Motors is not high enough to warrant the use of gasoline containing ethyl lead (colored) to overcome certain combustion characteristics, common to high compression, high speed engines; however, since most gasoline now on the market contains ethyl lead in various quantities, it can be used successfully in all models.)

Attaching the Motor to the Boat

It is essential that the motor be properly mounted on the stern of the boat to get results. The object is to be sure that the propeller operates at correct depth below the surface of the water and that the line of propeller drive is horizontal or parallel to the line of boat travel.

Height of the stern governs the depth at which the propeller operates—the angle of propeller drive being determined by adjustment of the thrust socket. Fig. 4.

For maximum efficiency, the following stern heights are recommended.

Model	Recommended Stern Height
110	15 Inches
210	15 Inches
LS	15 Inches
DS	15 Inches
LT	15 Inches
DT	15 Inches
AA	14 Inches
KA	15 3/8 Inches
PO	16 1/2 Inches

Should the stern be too high, cavitation will occur (see cavitation, page 40); if too low, a Large Portion of the Gearcase Will Be Exposed Below the Surface of the Water, resulting in excessive drag to retard boat speed.

(Note: If the stern of the boat is exceptionally high and cannot be cut down, longer driveshafts are available at nominal extra cost.)

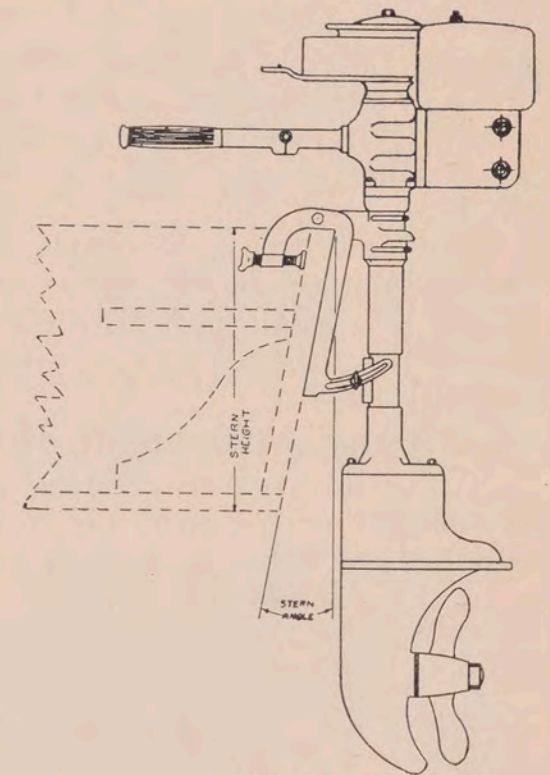

Fig. 4.

Thrust Socket Adjustment (Angle of Drive)

Since most boats are constructed with stern angle, it will be necessary to estimate the proper angle of drive with relation to the angle of stern.

The boat should "plane" or ride on an even keel.

Hang motor on the stern of the boat. Be sure to tighten clamp screws to prevent the motor from dropping overboard on sharp turns. This is IMPORTANT. (Do not use a wrench.)

Tilt motor to estimated angle, loosen thrust socket nut, Fig. 14. Slide thrust socket up on quadrants until it rests firmly against driveshaft housing. Tighten thrust socket nut.

Start motor and operate at full throttle. Should the boat have a tendency to "squat" or ride with the bow high out of the water, it would indicate that the motor was tilted too far from the stern. The angle of drive, being directed downward, will result in a downward thrust on the stern, likewise, the squatting effect.

If the motor is tilted too close to the stern, the boat will be hard to control, with the bow "digging" or plowing into the water. If the larger type of motor is used, and high speed is permissible, ease of control will

be greatly impaired in that the boat will tend to "zig-zag" on its course. This is due to upward thrust exerted on the stern.

On the average boat with an evenly distributed load, the thrust socket should be adjusted to permit the driveshaft to operate at right angle to the surface of the water at full throttle.

The Co-Pilot

(All Models Except 110, 210 and PO)

The CO-PILOT is an automatic mechanical device to assist in maintaining a true course of the boat whenever the steering handle is left free. This permits moving about in the boat without slowing down or stopping the motor to prevent its swerving to one side or the other. It also is of value when trolling or casting from the boat.

Its construction is simple in that the torque impulses of the motor are absorbed by the two small springs, shown in Fig. 5, preventing the motor from pivoting in the swivel-socket.

Care and Adjustment of Co-Pilot

If for any reason steering is found to be too free or too stiff, adjustment can be obtained by either tightening or loosening the Co-Pilot band nut. Fig. 5.

The Co-Pilot is in constant action during the time the motor is being operated and should be oiled occasionally; a drop or two on the Co-Pilot band and swivel bracket from time to time will do.

Adjustment of Swivel Bracket

(All Models)

To obtain adjustment of tilting tension, tighten or loosen tilting bolt nut. Fig. 13.

Tension of tilt should not be too great, but just sufficient to maintain the motor in any position of tilt.

STEERING TENSION ADJUSTMENT for the model is obtained by adjusting the swivel bracket screws to desired tension.

Mounting Motor on Canoe

To mount the motor on a canoe or pointed stern boat proceed as follows: At a point where the canoe or boat is ten inches wide over all, draw a line across the deck, as illustrated in Fig. 6, at right angles to a line through center of the canoe; the distance C A should then be equal to the distance A E. On the left side of the deck, facing the stern, at a point where the line A B crosses the center of the inside sheer strip at E, bore a $\frac{1}{4}$ " hole. Now insert the bolt, furnished with the attachment, through the sheer strip from the inside of the canoe, bolt the left side of the casting down first.

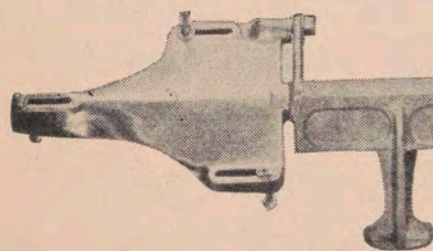

Canoe Bracket.

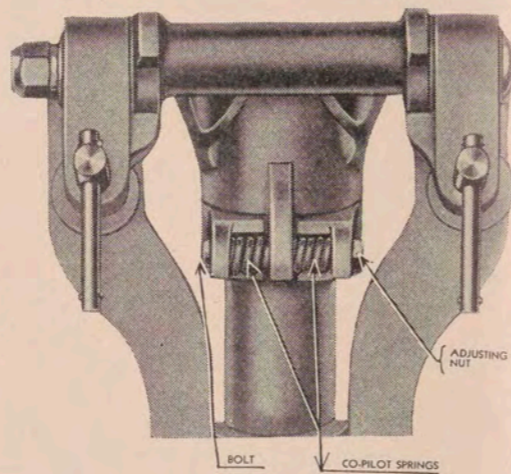

Fig. 5. Showing Co-Pilot.

After checking to see that the center line of the stern plate is directly over the line C E and while in this position bore two $\frac{1}{4}$ " holes in the right side of the sheer strip through the slotted holes in that side of the casting. This will insure correct position of deck plate.

Insert the two bolts through holes from the inside of the canoe, place washers on the bolts and tighten all three nuts securely. Place the motor in position by attaching to stern plate and tighten clamp screws. Adjust stern plate so that the driveshaft is in a vertical position when the canoe is under way. Be sure the cap-screw, holding thrust arm, is tightened securely, as well as the stern bracket clampscrews, to prevent motor from dropping overboard.

Before starting the motor make sure that the motor will turn completely around to any position without striking the canoe. If the motor is too far away from the hull of the canoe it may be shifted in by loosening the three deck bolts and moving the deck plate back the depth of the three slotted holes in the bracket.



Fig. 6. Canoe bracket installation.

To Break in New Motor

(All Models)

Under no circumstances should a new motor be operated at speeds beyond half throttle for at least ten hours. This time is required to properly seat the bearing surfaces, pistons, piston rings and cylinder walls.

Performance and long life depend to a great extent on the manner in which the motor was first operated.

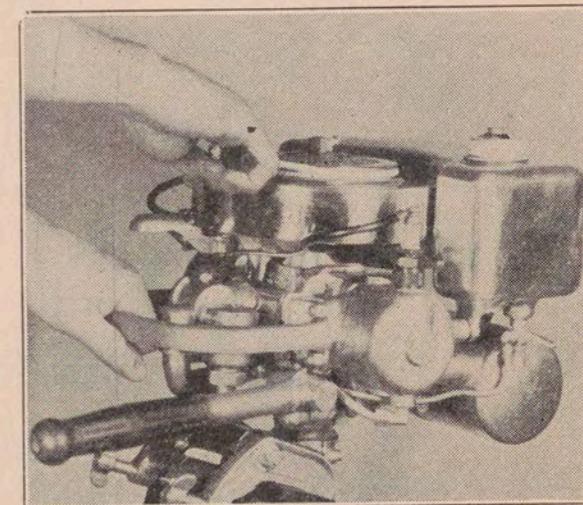

Fig. 7.

Starting

Starting of Johnson Motors is accomplished, first, by setting carburetor and position of magneto lever; second, by wrapping cord around starting plate and pulling quickly. (Fig. 7.)

NOTE—The DeLuxe Single (DS) and DeLuxe Twin (DT) are equipped with the "Ready Pull". Fig. 8.

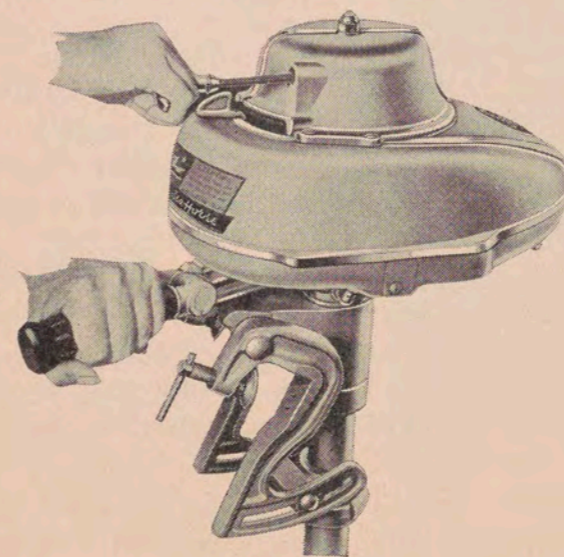

Fig. 8.

Controls

(All Models Except 110, 210 and PO)

Magneto and carburetor levers on all models except 110, 210 and PO are synchronized, that is, operating in unison upon moving the magneto lever. Fig. 9. This feature is of value in that any desired speed, within the limits of the motor, can be obtained by merely shifting position of the magneto lever; for full speed, shift to right; for intermediate and slow speeds shift to left (facing motor).

On models 110, 210 and PO, however, magneto and carburetor levers are operated independently, making it necessary to move the magneto and carburetor levers separately to obtain desired speed. Fig. 10.

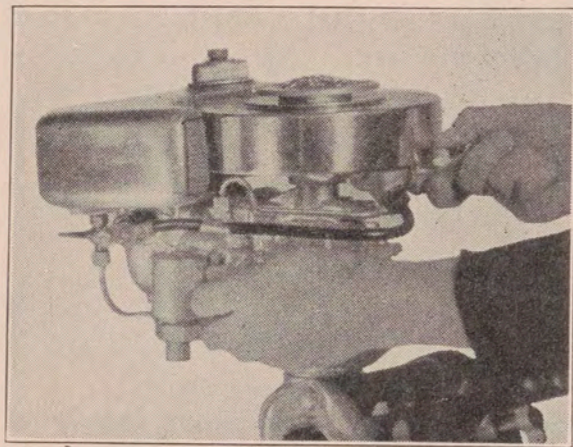

Fig. 10. Model 110 Control.

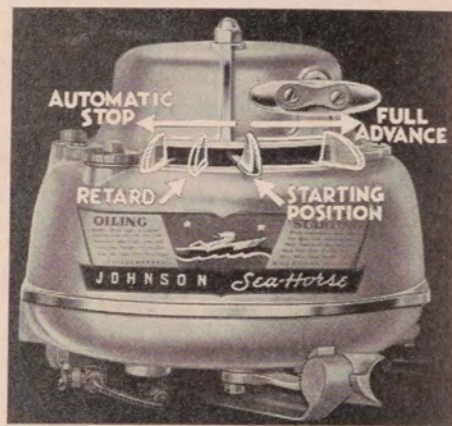

Fig. 9.
Control Models DS & DT

Lubrication of the Gearcase

Since the gearcase is submerged in water when in use, it is **IMPORTANT** that the gears, bearings, etc. be properly lubricated at all times.

INSPECTION of the gearcase is necessary at regular intervals to drain accumulation of water which may be present and to refill with fresh gear lubricant. (Remove "vent" and "grease" plugs).

Water in the gearcase is injurious if allowed to remain for any length of time, particularly if placed in storage, causing gears, bearings, propeller and pinion shafts to rust and become pitted.

To refill with gear lubricant, place motor in an upright position. Remove lower grease plug and upper vent plug. Fill with MOBIL UNDERWATER GEAR GREASE or SEA-HORSE GEAR LUBRICANT—using a grease gun or tube inserted through lower opening—until it flows from vent opening. Replace plugs—making certain they are secure. (Refer to motor illustrations on following pages.)

Prior to storage for winter months, be sure to remove all drain, vent and grease plugs to allow any water present in the gearcase and water channels to drain off. This will prevent freezing and bursting of the gearcase, driveshaft housing, water pump and cylinder blocks, if the motor is to be exposed to freezing temperatures, likewise, eliminates all danger of rusting.

Costly repairs can be avoided if above instructions are closely adhered to. See your Johnson dealer or Service Station for inspection and winter storage.

Starting Mixture

Since a rich starting mixture is essential for starting purposes, some arrangement must be built into the carburetor to accomplish it.

Models 110, 210, AA, KA and PO are equipped with carburetors which are provided with a choke, manually operated to obtain temporary rich mixtures for starting. See Figs. 11, 21 and 23.

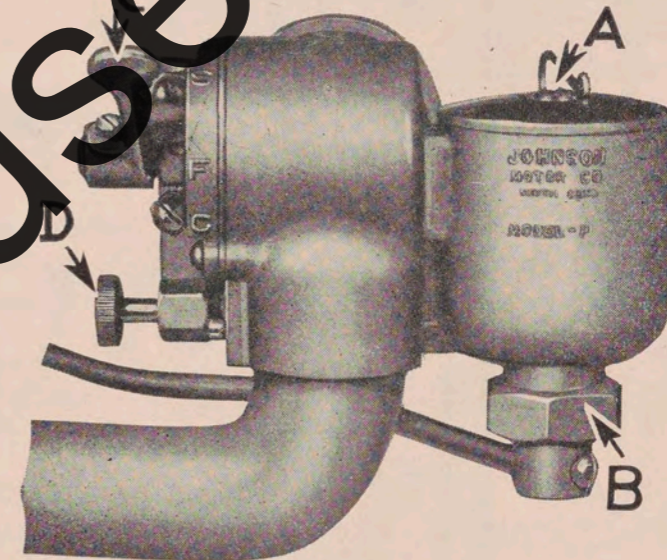

Carburetor used on Models 110 & 210.

"A" Float Pin, "B" Gas Line Nut.

"C" Carburetor Lever (Function is Two-Fold: To act as Choke for starting purposes and to control speed of motor). "D" Needle Valve.

Models LS, DS, LT and DT do not employ a choke built into the carburetor, but rely on the use of a primer (manually operated) to supply additional fuel for starting purposes. Fig. 12. The primer is operated by depressing the plunger, as desired to obtain the necessary starting mixture.

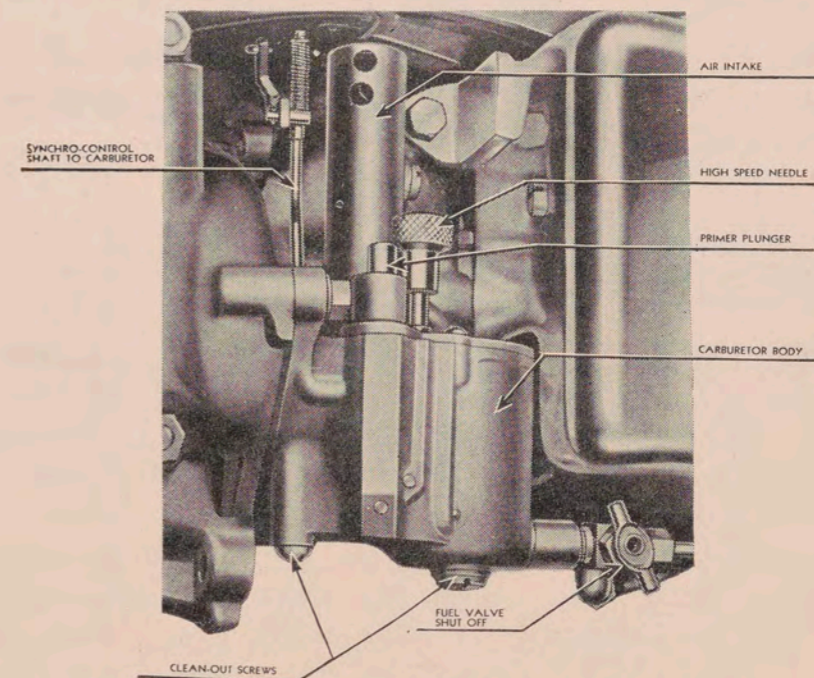
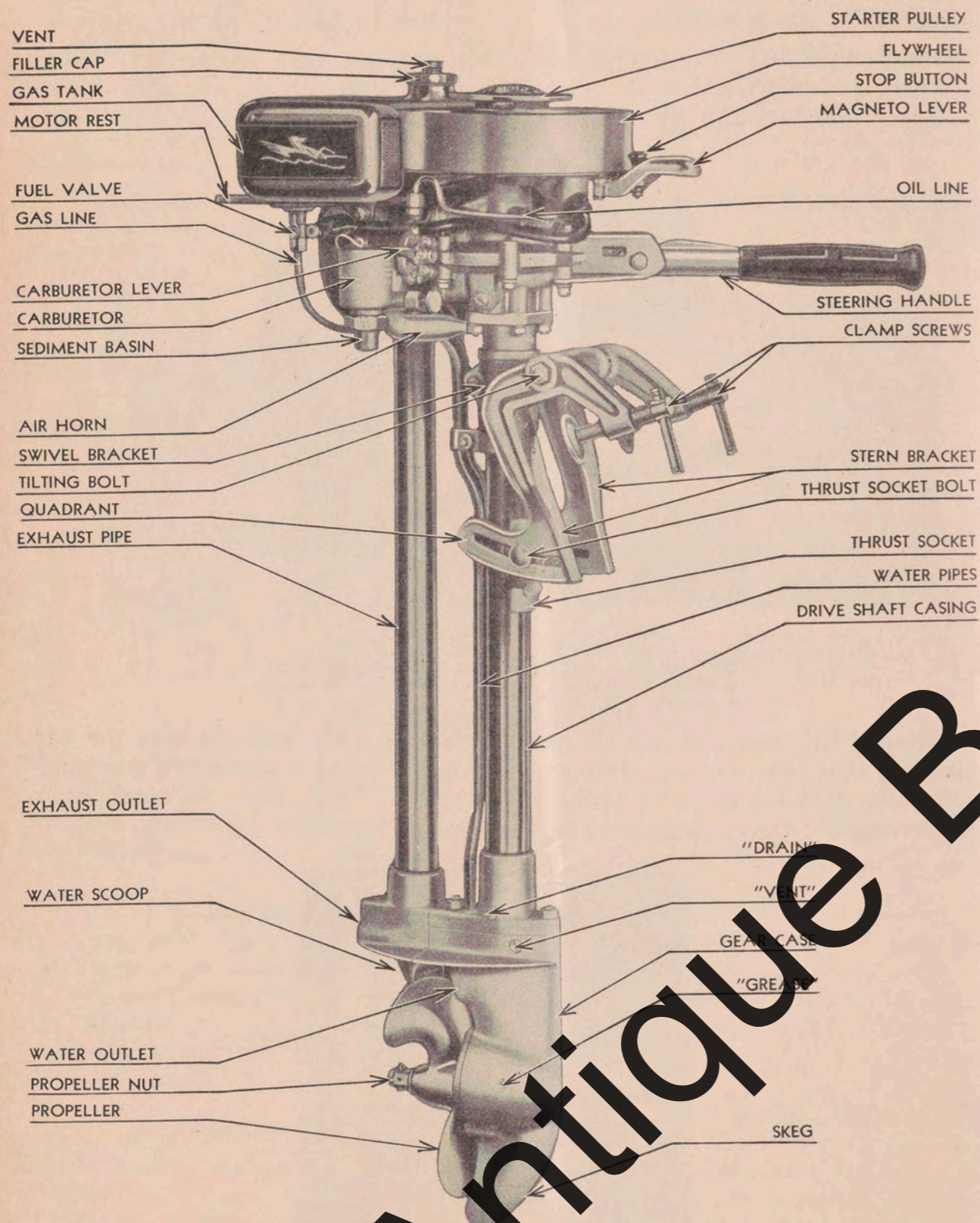

Fig. 12. Carburetor Wedge Models LS, DS, LT & DT.



Model 110

Fig. 13

Starting Instructions For

Models 110 and 210

(Fig. 13) (Fig. 14)

Open **air vent** (turn left) on gas tank filler cap.

Open **fuel valve** (turn left) underneath gas tank.

Needle Valve—Open 4 turns (model 110) 1 turn (model 210)—turn left.

Carburetor lever—Move down to position marked "C" choke. Fig. 11.

Spark (Magneto) lever—Move to center position.

Flush carburetor (cold weather only) by pressing down on float pin until fuel overflows.

Place knob of cord in notch of starting pulley. Wrap cord around pulley (clockwise)—grasp steering rail with left hand—pull rapidly on starting cord. Motor should start on two or three attempts. Fig. 7.

UPON HAVING STARTED MOTOR.

Advance spark by moving magneto lever to right (facing motor)
CAUTION—advance spark only far enough to obtain smooth operation, excessive spark advance may cause motor to slow down.

Carburetor lever—move to position marked "F" (fast) Fig. 11, immediately.

OPERATE IN THIS POSITION FOR SEVERAL SECONDS TO PERMIT WATER CHANNELS IN COOLING SYSTEM TO FILL WITH WATER.

Needle valve—close (turn right) as desired to obtain maximum speed. Familiarize yourself with this adjustment.

To reduce motor speed—Move carburetor lever upward to position marked "S" (slow). Retard spark by moving magneto lever to left (facing motor) to obtain desired speed. Fig. 11.

To stop motor—press down on stop button (red button on magneto lever), hold until motor stops turning.

To start warm motor—Make no adjustment on needle valve, use choke only if necessary.

Motor flooded by overchoking—Close needle valve and crank to start (clean spark plugs if necessary). As motor picks up speed, gradually open needle valve to running position.

BE SURE TO RUN MOTOR AT FULL SPEED FOR SEVERAL SECONDS AFTER HAVING STARTED TO PERMIT FILLING OF WATER CHANNELS IN COOLING SYSTEM WITH WATER. The motor can then be throttled down for slow speed operation without danger of overheating.

AFTER OPERATION IN SALT WATER—rinse off lower unit parts with fresh water and wipe with oily cloth. This will reduce the corrosive effects of salt water to a minimum. This is **IMPORTANT**.

Operate motor at $\frac{1}{2}$ throttle for at least 10 hours to break in.

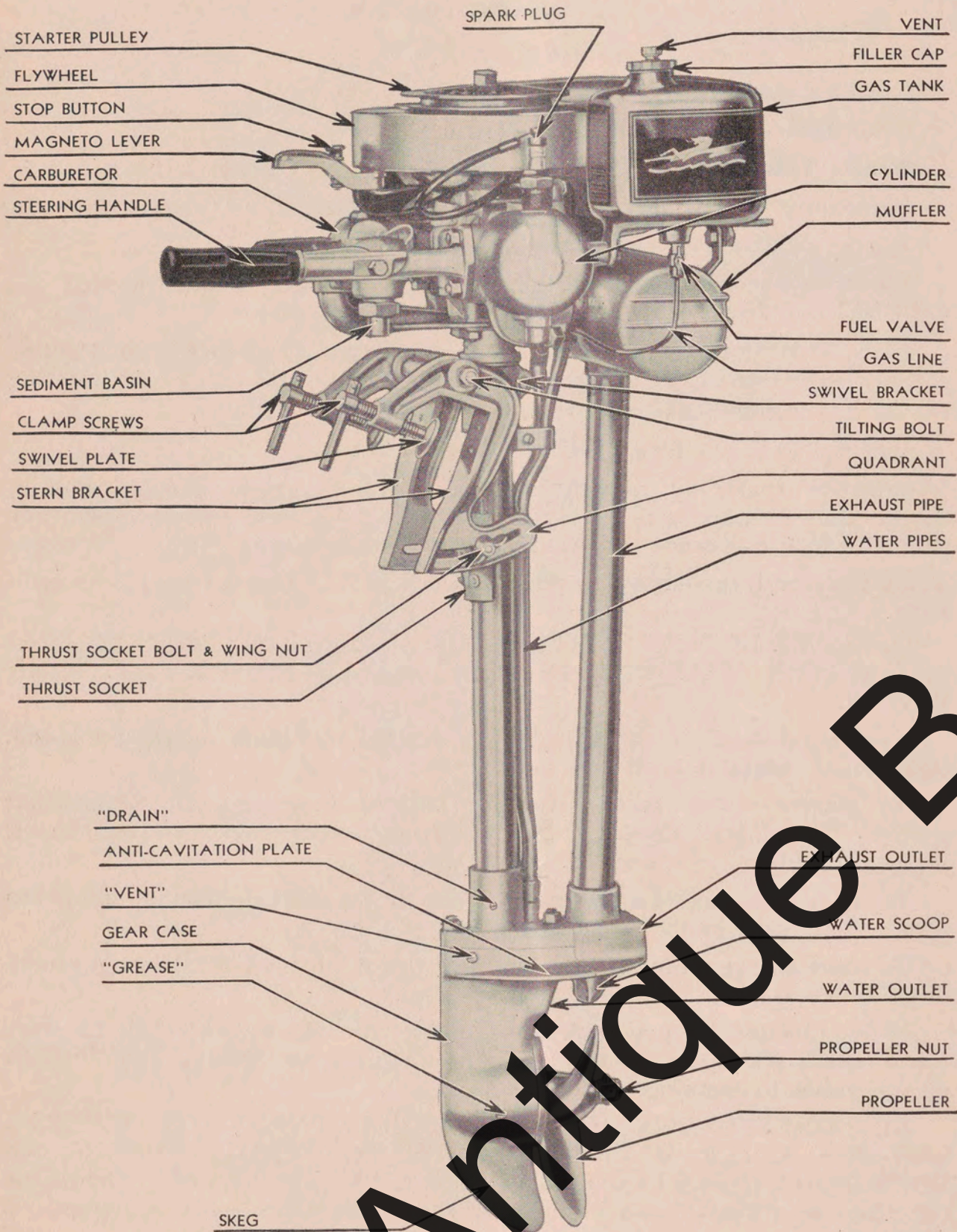

Model 210

Fig. 14.

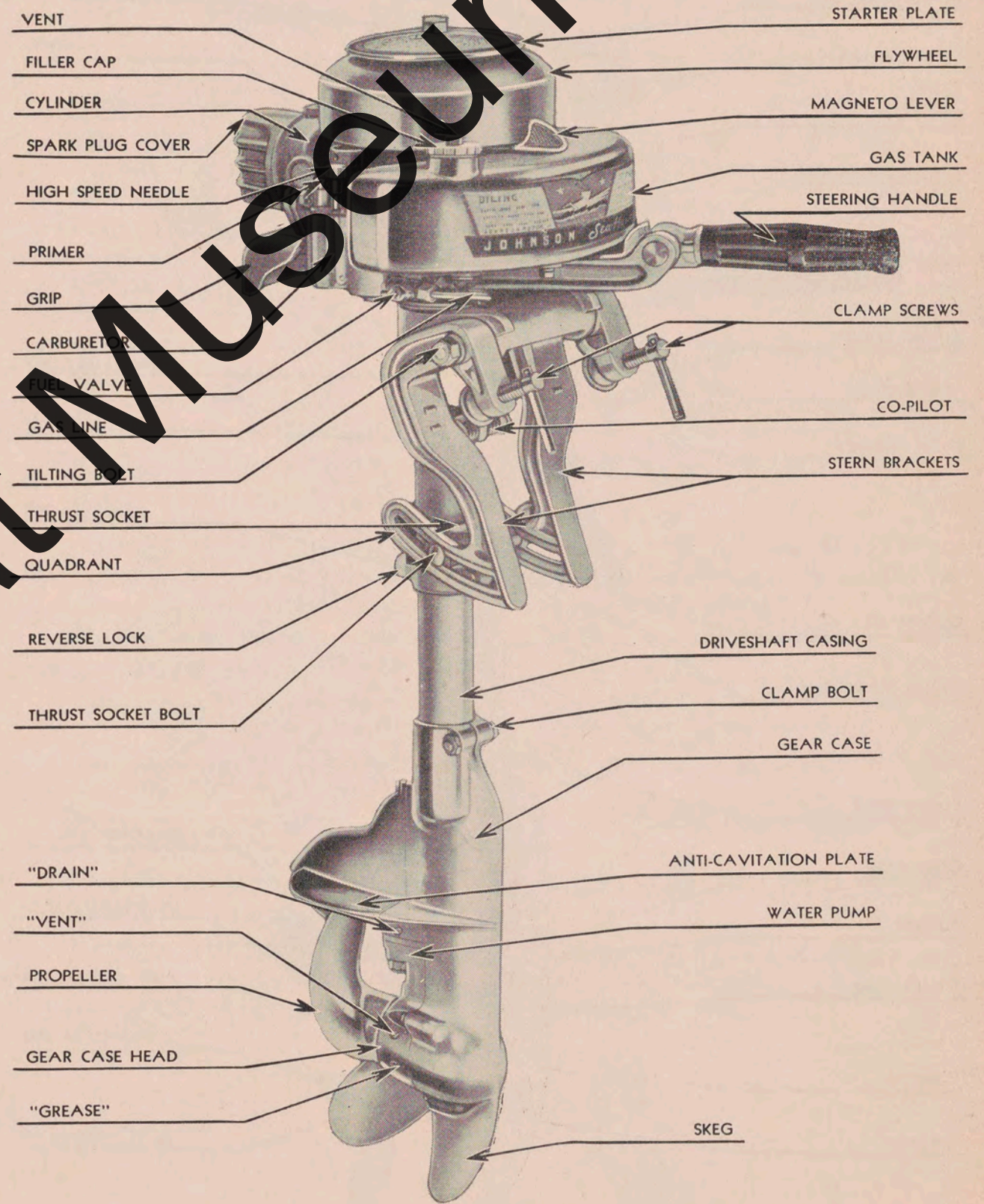

Model LS

Fig. 15.

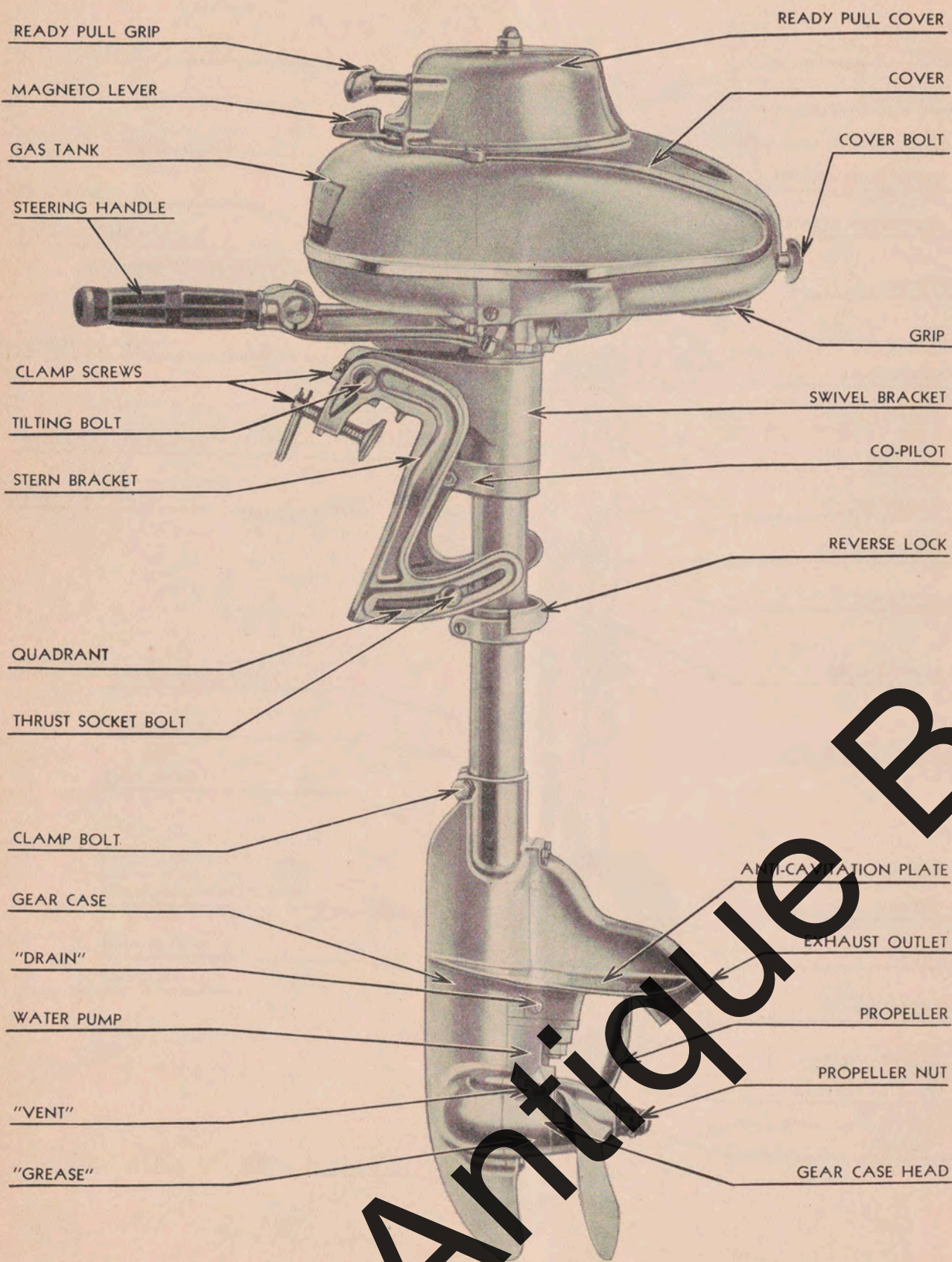

Model DS

Fig. 16.

Starting Instructions

Models	LS	DS	LT	DT
	(Fig. 15.)	(Fig. 16.)	(Fig. 18.)	(Fig. 19.)

Open air vent in gas tank filler cap.
 Open fuel valve underneath gas tank, adjacent to the carburetor.
 Needle valve—unscrew 1 to 1½ turns (turn left), when motor is cold—more if necessary in cold weather.

Magneto lever—Move to position about 1 inch to right of center, facing motor—fig. 9.

Primer button—Press down three or four times to obtain necessary right starting mixture, when motor is cold. Note—on models DS and DT, the primer and high speed needle are interconnected—press to prime and turn to adjust. Fig. 32.

To start—wrap cord around starting pulley (knot of cord in notch of starting pulley). Pull rapidly on starting cord. Note—Models DS and DT are equipped with the "Ready Pull" starter—simply pull on cord grip. Fig. 8.

UPON HAVING STARTED MOTOR

Advance spark by moving magneto lever to right (facing motor).

Since spark and carburetor levers are synchronized, control of the carburetor is accomplished by maneuver of the magneto lever.

Close needle valve—(turn right) as required to obtain maximum speed (adjust at full spark advance).

Note—If motor tends to slow down after starting, press down on primer button several times. Open high speed needle valve if necessary.

To reduce motor speed—retard spark by moving magneto lever to left. (facing motor).

To stop motor—move magneto lever to extreme left, (facing motor) hold until motor stops turning. See Fig. 9.

OPERATE NEW MOTOR AT ½ THROTTLE FOR AT LEAST 10 HOURS TO PROPERLY BREAK IN.

AFTER OPERATION IN SALT WATER—rinse off lower unit parts with fresh water and wipe with oily cloth. This will reduce the corrosive effects of salt water to a minimum. This is IMPORTANT.

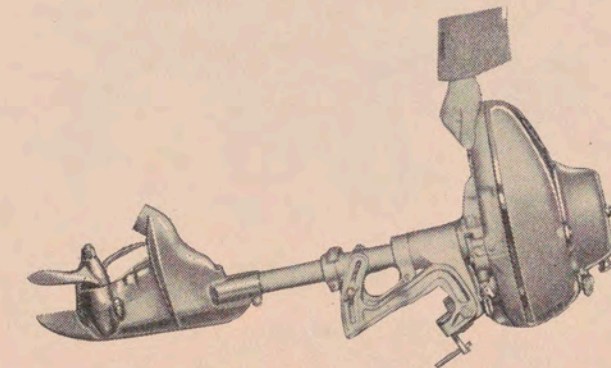
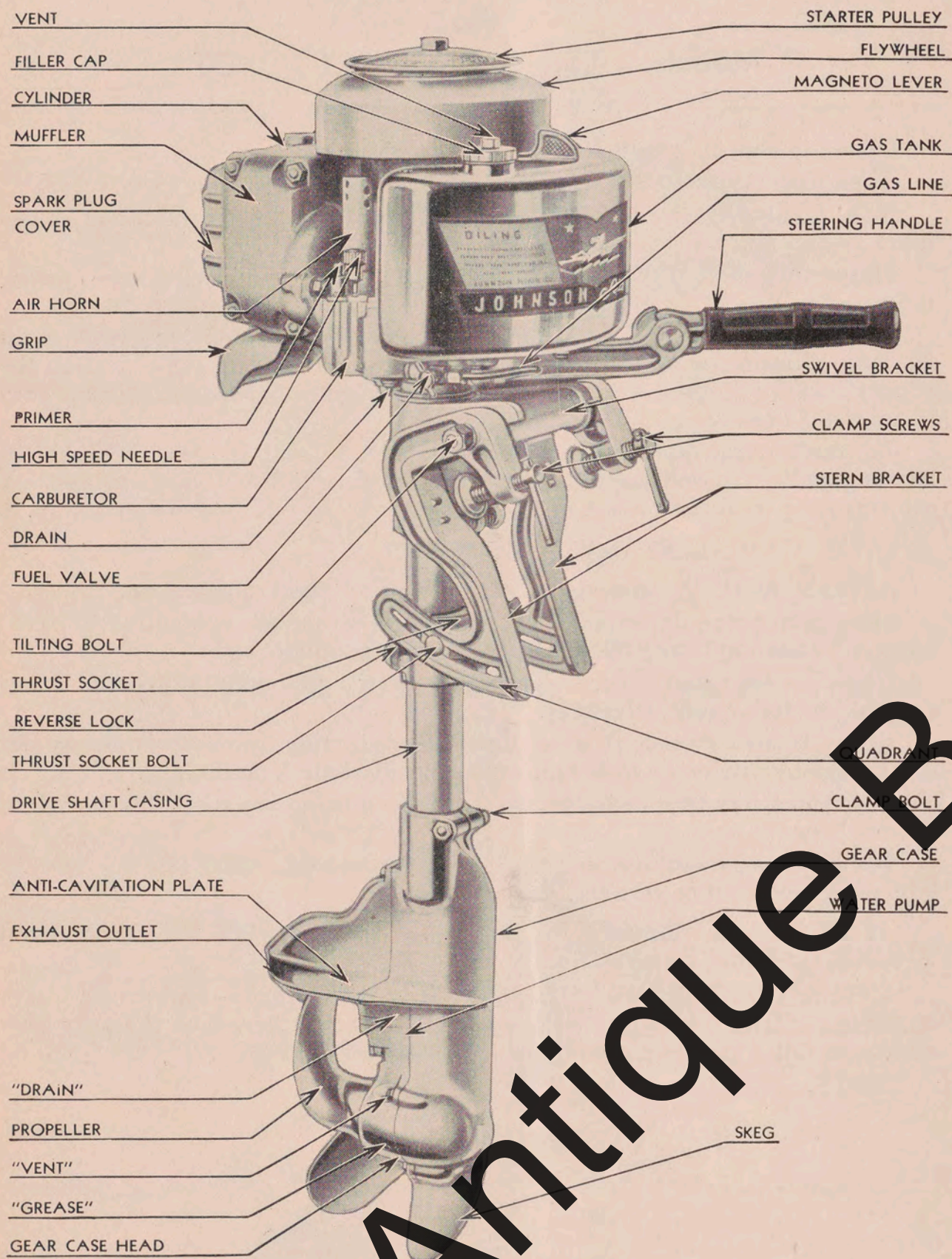
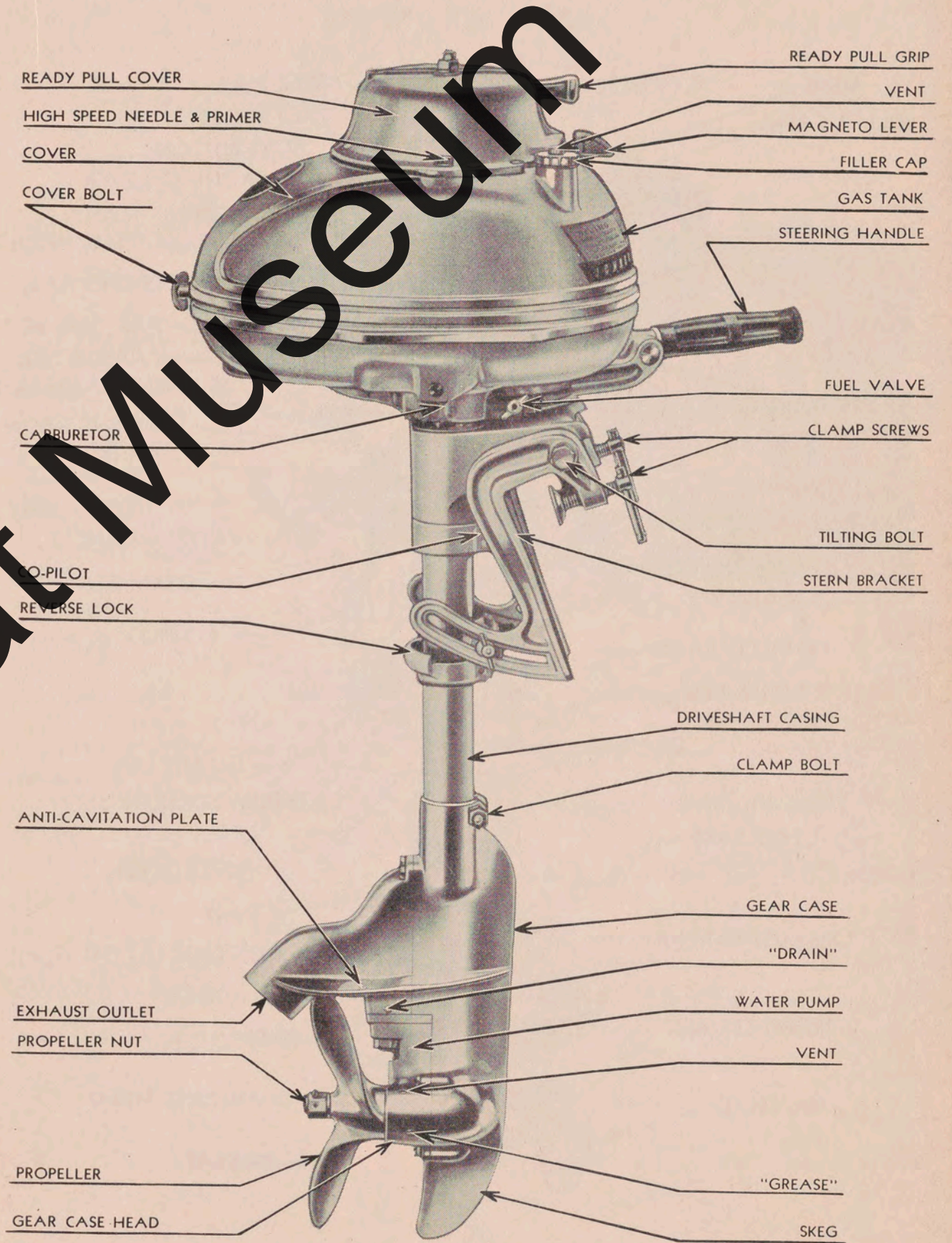

Fig. 17. Showing how Models DS & DT are carried.



Model LT

Fig. 18.



Model DT

Fig. 19.

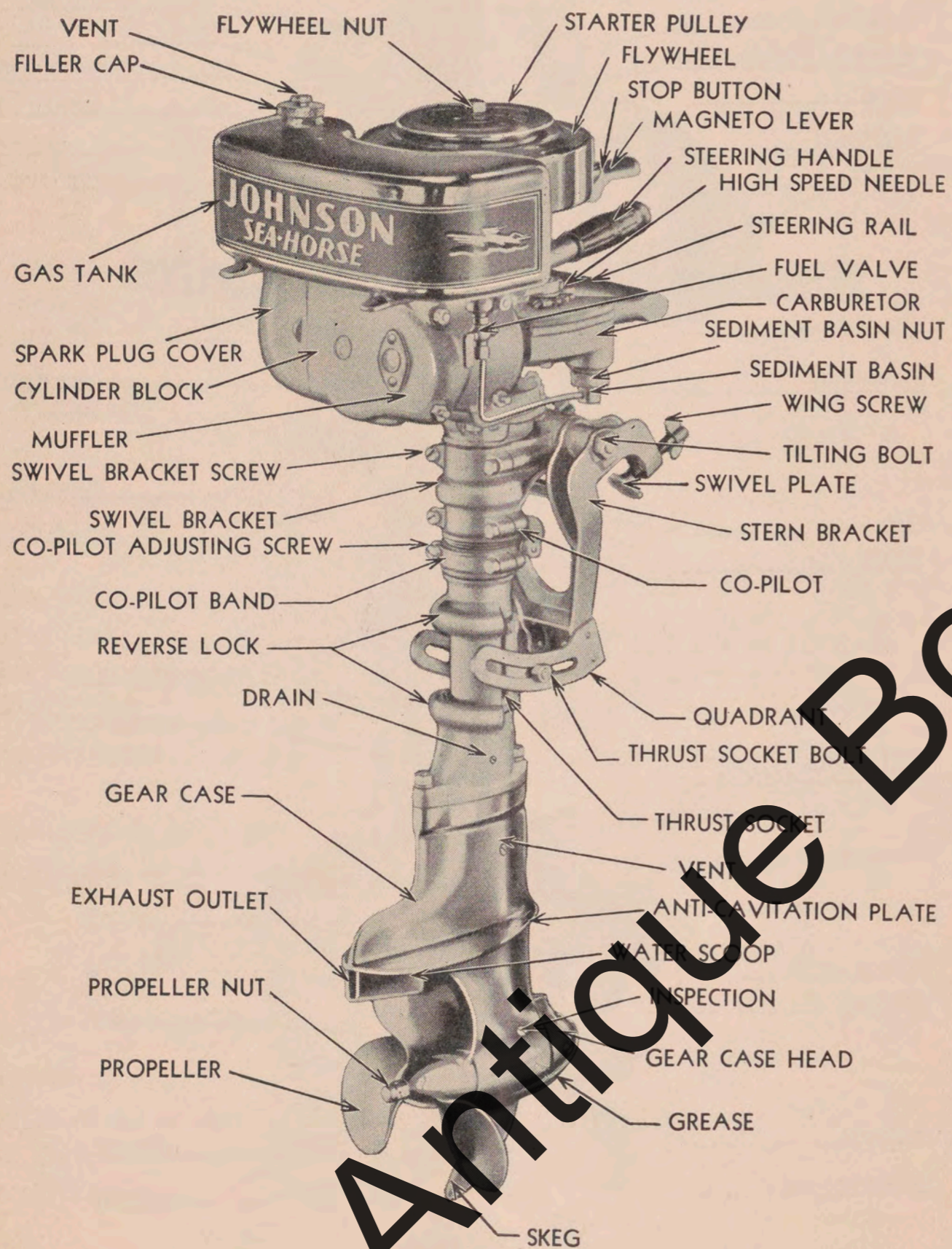

Fig. 20. Model AA

Starting Instructions

AA and KA Fig. 21

Open air vent in gas tank filler cap (turn left). Open fuel valve, (lever down). See Fig. 20. Unscrew high speed needle one turn (left) for cold motor—more if necessary in cold weather.

Move magneto lever to extreme left (facing motor), then back to center. See Page 31 Co-Incidental exhaust cutout.

TO START cold motor—Place knot of starting cord in notch and wrap cord around starting pulley. Move choke lever (see illustration) to extreme right (facing motor). Press down on float pin and hold until fuel drips from overflow on side of carburetor. Pull quickly on starting cord. (Use choke only if necessary to start warm motor.)

UPON HAVING STARTED MOTOR — As motor picks up speed, move choke lever back to original position until it snaps into place. Advance spark by moving magneto lever to right (facing motor)—magneto and carburetor levers are synchronized—see Page 23. Close high speed needle (turn right) as desired to obtain maximum speed. (This adjustment should be made at full spark advance.)

TO REDUCE MOTOR SPEED—Retard spark by moving magneto lever to left (facing motor).

TO STOP MOTOR—Press down on stop button and hold until motor stops turning (red button on magneto lever).

FLOODED MOTOR—If motor is flooded by overchoking, close high speed needle and crank to start (clean spark plugs if necessary)—as motor picks up speed open high speed needle gradually to running position.

TO BREAK IN NEW MOTOR—Operate at least ten (10) hours at half throttle.

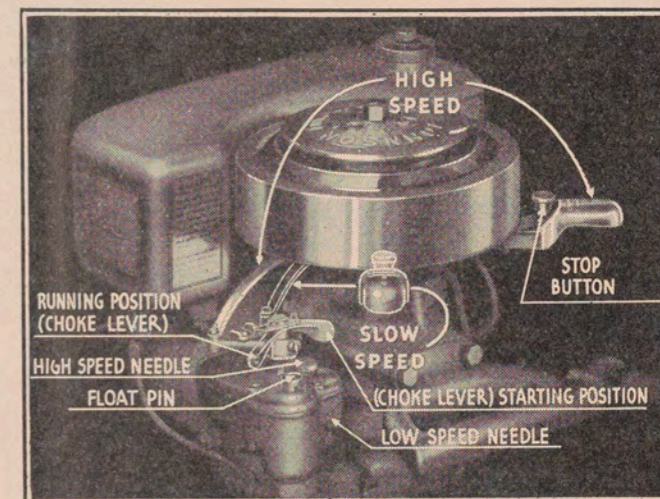
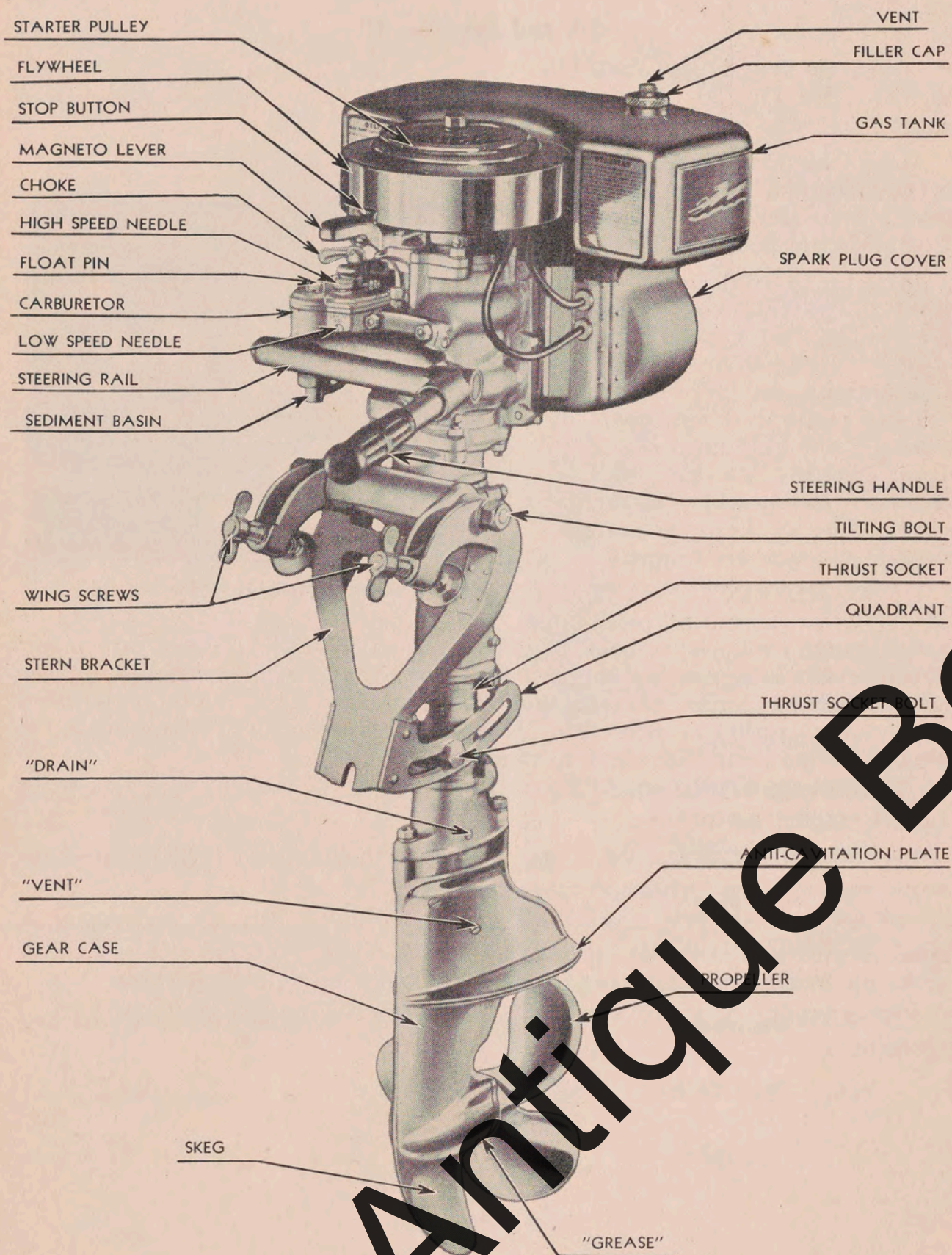

Fig. 21 Showing Controls on Models AA and KA



Model KA

Fig. 22

To Start Model PO.

Open air vent in gas tank cap. Open fuel valve. (Handle down.) Unscrew high speed needle one turn, Fig. 23, more if necessary in cold weather. Set carburetor control approximately one-third open. Move choke lever to position marked "choke" (Do not use choke when motor is warm unless necessary). Set magneto lever at center position.

COMPRESSION RELEASE. Move lever to extreme right (facing motor).

TO START. Wrap cord around starting pulley. Press down on float pin for approximately two seconds to flood carburetor. Pull quickly on starting cord.

UPON HAVING STARTED MOTOR, move choke lever to position marked "run" immediately.

COMPRESSION RELEASE. Move lever to extreme left (facing motor). Advance spark by moving magneto lever to right (facing motor).

Open throttle valve as desired. Close high speed needle (turn left) as required to obtain maximum speed. See Page 29. (Throttle open—spark full advance.)

TO REDUCE MOTOR SPEED, close throttle valve, retard spark by moving magneto lever to left (facing motor).

TO STOP MOTOR, press down on stop button. Hold until motor stops turning.

FLOODED MOTOR. If motor is flooded by over choking, and cannot be started, close high speed needle—crank motor to start and allow to run until excess fuel in crankcase is consumed. Open high speed needle and start again as instructed above.

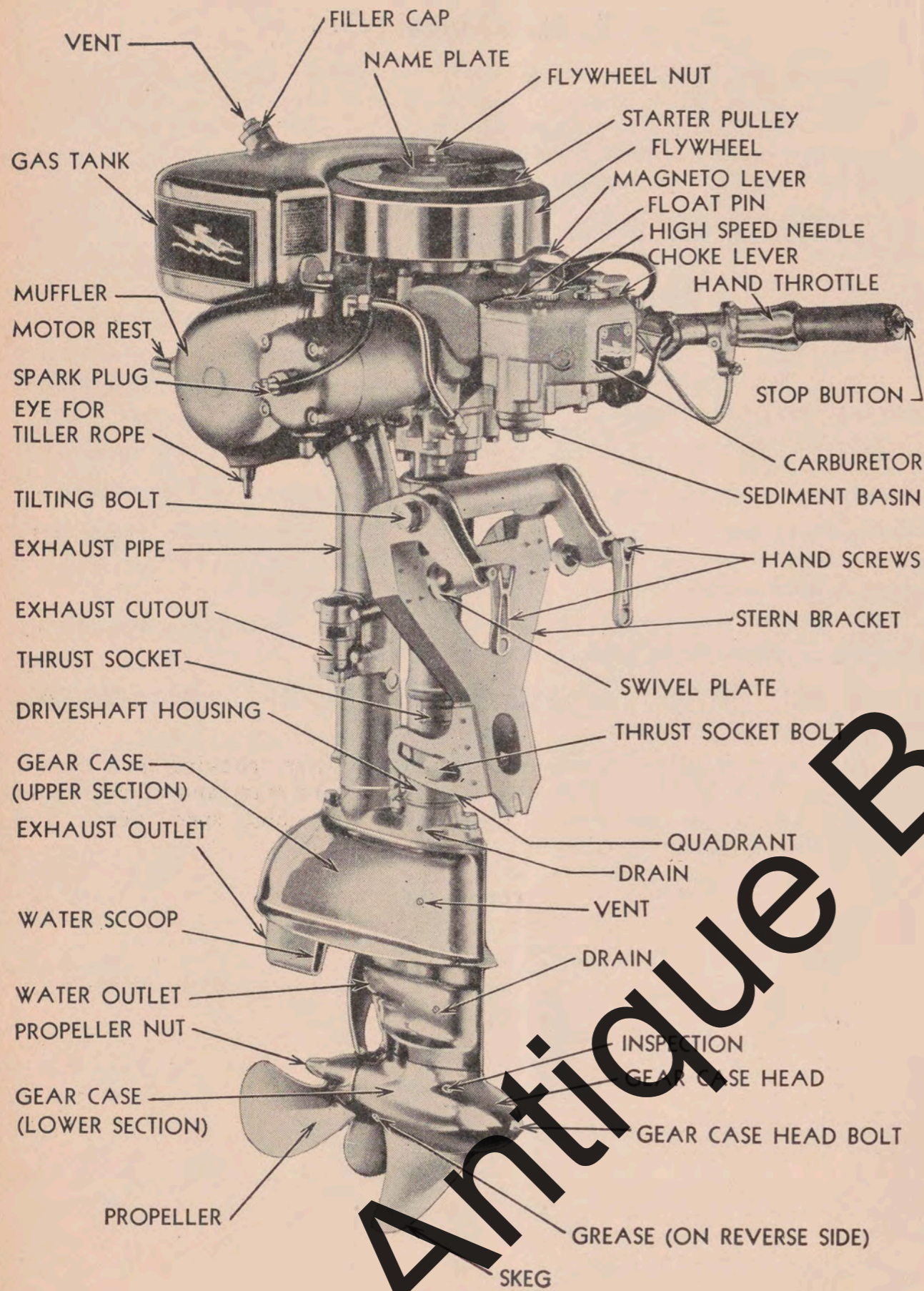

Model PO

Fig. 23

The Ready Pull

This simple device is built into models DS and DT for the express purpose of eliminating the necessity of manually wrapping the cord around the starting pulley for cranking. Fig. 8. It consists of a ratchet plate about which are coiled the return spring and the starting cord and a pawl arrangement mounted on top of the magneto flywheel. Fig. 24.

When at rest, the pawls are held in an extended position by small springs, making a positive connection with the ratchet—thus when pulling on the starting cord grip, cranking effort is applied directly to the flywheel.

Upon having started the motor, the pawls disengage the ratchet automatically due to centrifugal force created by rotation of the flywheel. Once having started, "Ready Pull" mechanism remains idle, consequently since there is no action while the motor is in operation, there can be no wear on any of the parts. It is for this reason very little attention is necessary.

Immediately upon stopping the motor, centrifugal forces cease to act causing the springs to extend the pawls to engage with the ratchet—the "Ready Pull" is then again in position for cranking. Its action is automatic—simply pull on the cord to crank.

Care of the "Ready Pull"—Under no circumstances let the starting grip "snap" back into position after cranking by letting go. Retain hold of the grip until the cord has returned to normal position. Care should be exercised in this respect to prevent possible injury to the "Ready Pull" cover and starting cord.

In event the starting cord should break, remove the "Ready Pull" and crank motor in usual way by wrapping cord around auxiliary starting plate on the flywheel.

TO INSTALL NEW STARTING CORD proceed as follows—

1. Remove "Ready Pull".
2. Remove fragments of broken starting cord.
3. Obtain new cord. Attach grip as shown Fig. 26. Cord should be "Long".
—Use only the special cable provided by the manufacturer.
4. Cut a small piece of wood to fit in ratchet as shown in Fig. 25.
5. Turn in anti-clockwise direction (right to left) 7 turns, using marker as indicated. Fig. 25.
6. Insert starting cord as illustrated. Fig. 25. (Be sure to turn right to left—to do otherwise will damage the recoil spring.)

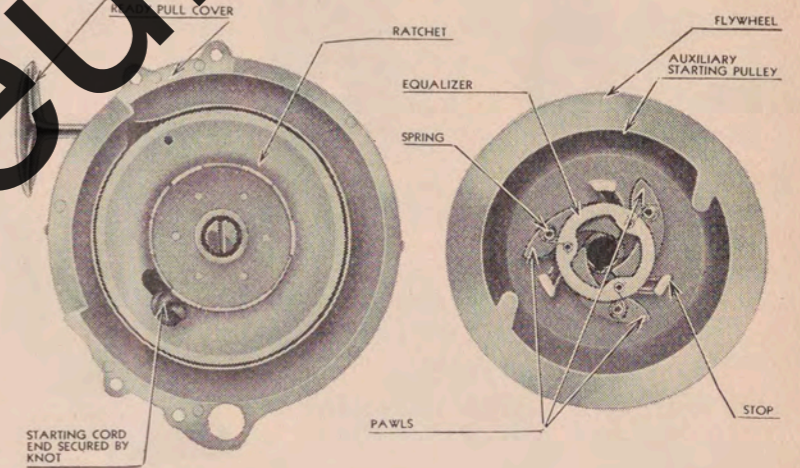

Fig. 24

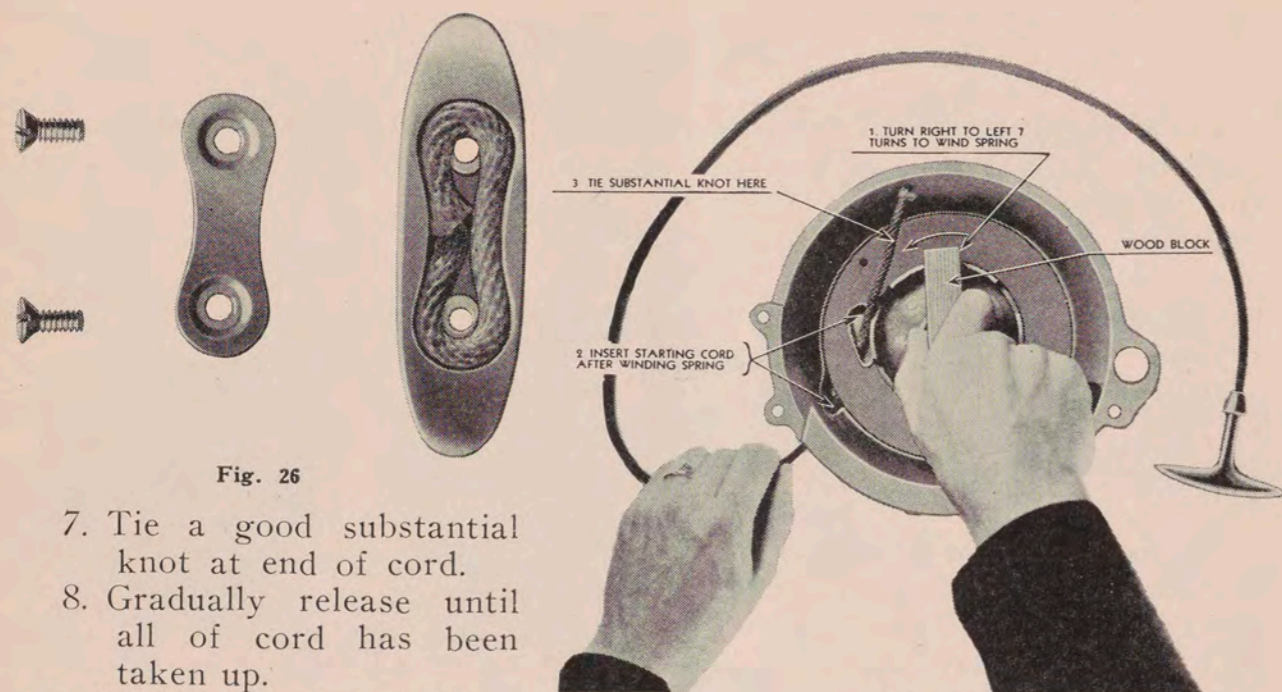
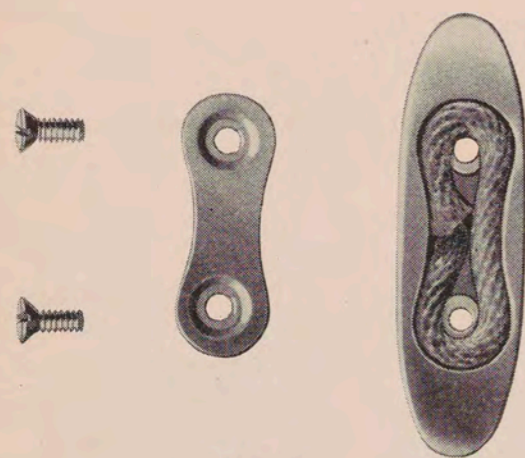

Fig. 25

7. Tie a good substantial knot at end of cord.
8. Gradually release until all of cord has been taken up.
9. Attach "Ready Pull" to motor.

Fig. 26



Compression Release and By-Pass Valve PO Only

To obtain easy cranking and starting of the model PO a compression release and by-pass valve have been built into the port cylinder (left, back to motor.)

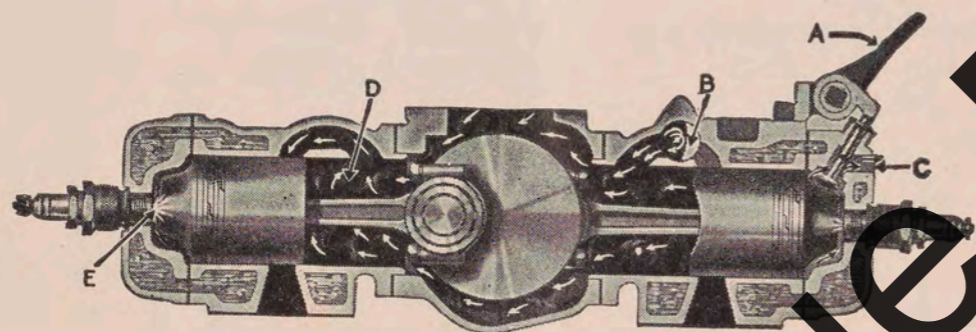

The compression release "C" consists of a small valve installed in the cylinder head—held closed by a spring and operated at will by movement of the compression release lever "A". Its function is to relieve compression pressure, when opened for starting purposes, thereby, reducing cranking effort, since starting is accomplished only at one cylinder.

The by-pass valve "B", interlinked with compression release valve, is merely a gate in the by-pass chamber of the cylinder. Its purpose is to close off compression discharge to the port cylinder, resulting in the starboard cylinder (right, back to motor) receiving full compression discharge from crankcase to further facilitate easy starting.

The compression release and by-pass valve operate in unison by movement of the compression release lever "A"—lever moved to right (facing motor), compression release valve open, by-pass valve closed (starting position); if moved to left (facing motor) compression release valve is closed and by-pass valve open (running position).

Carburetor Adjustment Models 110 and 210

Single jet—Fig. 11. Simply turn needle valve "D" to right (for less gasoline) or left (for more gasoline) as required to obtain maximum speed and smooth operation.

Models AA, KA and PO

Carburetors are of the full range type, that is, constructed with two jets to insure efficient carburetion throughout the entire speed range of the motor. The low speed jet provides correct carburetion at low and intermediate speeds; the high speed jet from intermediate to top speeds. Fig. 21.

Two adjustments are thus necessary—low and high speed needles.

Low speed adjustments are made at the factory and should not be altered unless circumstances require it.

TO ADJUST LOW SPEED, (low speed adjustment should be made with retarded spark and at normal running temperature)—Close low speed screw or needle (turn right until it rests gently on its seat). Open $\frac{1}{2}$ turn (turn left). Start motor as instructed and operate at full throttle until it reaches normal temperature. Move magneto lever midway between center position and full retard. Turn low speed needle to right or left as required to obtain smooth operation at low speed.

TO ADJUST HIGH SPEED—start motor as instructed. Operate at full throttle and full spark advance until motor reaches normal operating temperature. Turn high speed needle to right or left as required to obtain maximum speed.

Models LS, DS, LT, and DT

Carburetion of these models is of the full range type but differs somewhat in construction from the above in that only the high speed needle and jet are built into the carburetor body. The low speed needle and jet are actually not a part of the carburetor proper—this feature is part of the crankcase assembly as shown in Fig. 26A, and functions throughout the entire speed range of the motor.

Since both third port and rotary valve principles are employed, there are two independent systems of carburetion. The carburetor itself is of the conventional type—consisting of a float chamber, mixing chamber, throttle valve, needle for adjusting mixture and a connection to the intake manifold. The carburetor and third port operate only at intermediate and high speeds and cease to function entirely at low speeds. Low speed operation is maintained, however, by mixing air

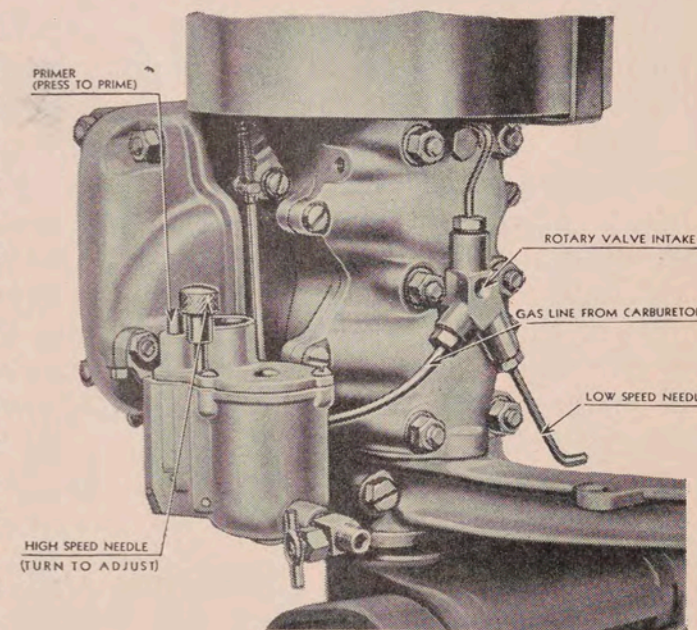

Fig. 26A

and gasoline in the low speed opening which is conducted to the crankcase chamber by way of the rotary valve. Fig. 27.

TO ADJUST CARBURETOR—proceed as follows — (Carburetors are properly adjusted prior to shipping motors from factory. Some adjustment may nevertheless be necessary due to the type of service or temperature and climatic conditions).

There are two adjustments—High and Low speed. Fig. 26-A.

Turn Low Speed needle to right to close until it rests gently on its seat. Unscrew $\frac{1}{2}$ turn (turn left).

Close High Speed needle by turning to right until it rests gently on its seat. Unscrew 1 to $1\frac{1}{2}$ turns (turn left).

Start motor as instructed on page 19.

Operate at full speed with spark at full advance until motor reaches normal running temperature. Turn High Speed needle to right or left as required to obtain maximum speed.

Retard spark by moving magneto lever to position midway between center and full retard (left of center facing motor). Turn Low Speed needle to right or left as desired to obtain smooth and consistent running at low speeds. Once the low speed is properly adjusted it will require no further attention.

Spark and magneto levers are synchronized, therefore movement of the magneto lever controls both spark and carburetor simultaneously.

THE PRIMER consists of a small cylinder and plunger built into the carburetor body, which, when depressed, forces a small amount of gasoline into the low speed opening to provide rich starting mixture. Since priming is accomplished through the low speed opening, the low speed needle must be open. The motor cannot be primed if the low speed needle is closed. Do not, however, open the low speed needle beyond that required for best low speed operation of the motor.

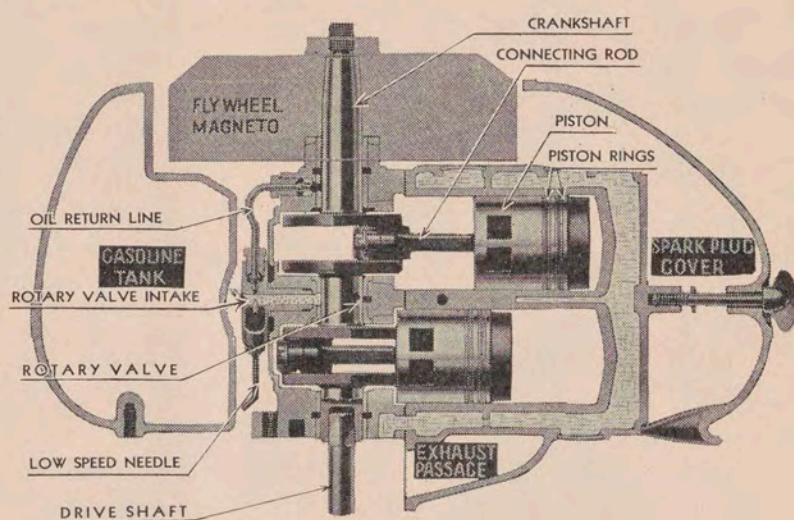

Fig. 27

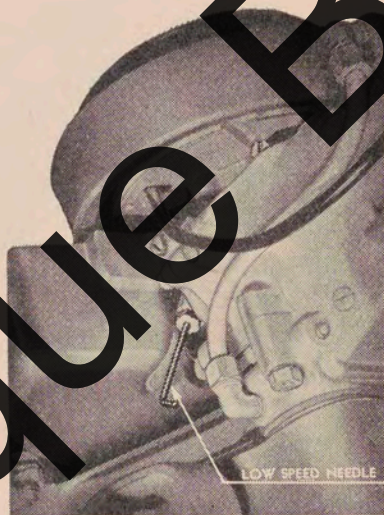

Fig. 28—Showing Location of Low Speed Needle Models LS, DS, LT and DT.

Steering and Reverse

Steering is accomplished by moving the steering handle to right or left as desired. The motor pivots in such a way that direction of boat travel is governed by the propeller thrust, enabling full control of the boat the instant the motor is started.

All models, except 110, 210 and PO, permit full pivot (360°) steering,

REVERSE being obtained by simply raising the steering handle and turning the motor completely around to reverse position. A reverse lock arrangement built into the thrust socket and driveshaft housing prevents tilting in reverse.

CAUTION: Be careful not to strike submerged obstructions when in reverse—the motor does not tilt in reverse.

Co-Incidental Exhaust Cut-Out

(AA & KA Only)

To further facilitate easy starting and to maintain quiet operation of the AA and KA Alternate Firing Twins, a Co-Incidental Exhaust Cut-Out has been provided to relieve back pressure created by the under-water exhaust during time of starting.

Located in the passage, conducting exhaust gases to the driveshaft housing, its operation is synchronized with movement of the magneto lever.

By an arrangement of linkage between the cut-out and magneto levers, the cut-out remains closed until the spark is retarded well beyond the center position to permit quiet operation at intermediate speeds. However, upon advancing from full retard, the cut-out does not close until the magneto lever is moved past center position (starting), thus, relieving back pressure for starting purposes only.

IMPORTANT: To start the AA and KA Alternate Firing Twins, the magneto lever should first be moved to full retard (left facing motor) then back to center to make certain the cut-out is open.

Automatic Exhaust Cut-Out PO Only

An automatic exhaust cut-out is built into the exhaust tube on the PO to relieve back pressure for starting purposes and operation at low speeds.

It consists of a small plunger fitted into a cylinder, the end of which has an opening leading into the exhaust tube. Operation of the plunger is controlled by water pressure in the cooling system.

At low or starting speeds, the plunger rests at the bottom of the cylinder—exhaust gases are free to flow out through by-pass above the surface of the water, thus, relieving pressure as shown in Fig. 29.

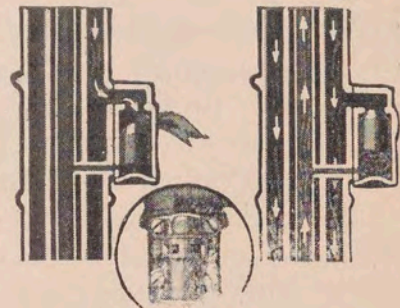

Fig. 29

At intermediate and high speeds, the plunger is forced upward by water pressure created in the cooling system. In this position the exhaust by-pass is closed, all exhaust gases being emitted below the surface of the water.

The Magneto

The magneto, as supplied on all Johnson Outboard Motors, is a self-contained unit—requiring no assistance from outside sources such as a dry cell or storage battery to produce the strong spark so essential to easy starting. It consists chiefly of an armature plate, on which are mounted the ignition coil, condenser and breaker points and a permanent magnet built into the flywheel. See Figs. 30 and 31.

Its operation is extremely simple. As the pole pieces of the magnet pass over the heels of the coil, a magnetic field is built up about the coil, causing a current to flow thru the primary winding.

At the proper time, the breaker points are separated by action of a

cam, thus breaking the primary circuit. This stops the flow of primary current, which causes the magnetic field about the coil to break down instantly—an electrical current of exceptionally high voltage is induced in the fine secondary windings of the coil, and is carried to the spark plug where it jumps the gap between the points of the plug to ignite the compressed charge in the cylinder.

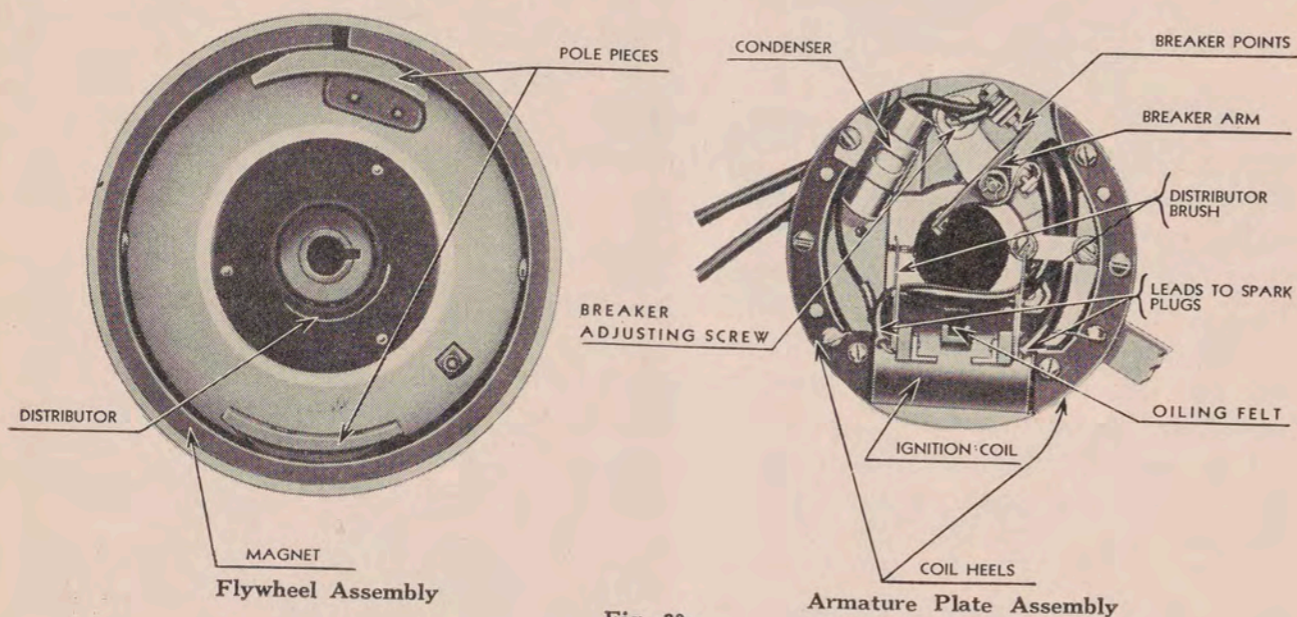

Fig. 30

Magneto Used on Models LS, DS, LT and DT

Care of the Magneto

Due to its simple and rugged construction, the magneto will perform efficiently throughout the entire life of the motor. It requires no lubrication, therefore, little or no attention other than an occasional inspection of the breaker points and electrical connections.

Should you find the motor a bit difficult to start after having used it for some time and have reason to suspect the ignition of being at fault, examine first, condition of spark plugs and connections. If found to be in good condition, the difficulty might be due to pitted or corroded breaker points.

This can be determined by removing the cover plate from the flywheel of the magneto dome. An inspection hole in the dome provides access to the breaker points for inspection and adjustment.

Note—Models LS, DS, LT and DT do not have flywheels equipped with an inspection port. It is therefore necessary to remove the flywheel as instructed on page 34 when inspection of the breaker points is desired.

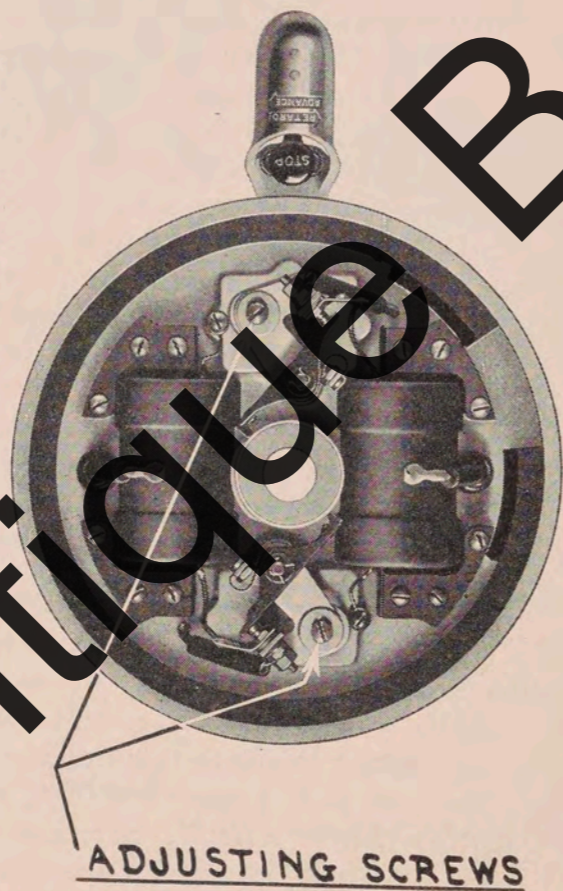

Fig. 31—Magneto Armature Plate used on Models AA & KA

Spread breaker points with a blunt instrument. If found to be pitted, place a narrow strip of 00 sandpaper between the points, folded in such a manner that both points can be dressed down simultaneously by drawing back and forth between the points. (Do not use emery cloth.)

Upon completion of this operation, it is well to check the gap between the points. This can be accomplished by turning the flywheel slowly until the points are wide apart. Insert a feeler gauge between the points—correct setting should be .020". Should you find it necessary to make corrections, loosen the adjusting screws. If the gap is too great, move the breaker assembly away from cam; if too narrow, move towards cam.

(Note: Breaker points should be adjusted to .020" gap setting—points on verge of opening when mark on rim of flywheel and mark on armature plate index or arm.)

Be sure the flywheel is secure at all times. **TIGHTEN FLYWHEEL NUT OCCASIONALLY ON A NEW MOTOR.**

If further corrections are required, consult your nearest Service Station. See Pages 44, 45 and 46.

Spark Plugs

Due to the different speeds at which the various models operate, it is **IMPORTANT** that spark plugs of certain characteristics be installed in each model.

The following spark plugs are recommended for:

Model	Our Part No.	Spark Plug	Substitute
110	76-140	Champion J6 (14MM)	AC K9
210	76-134	Champion C7	AC G8
LS	76-152	Champion J8	
DS	76-152	Champion J8	
LT	76-152	Champion J8	
DT	76-152	Champion J8	
AA	76-112	Champion 5M	AC G3½
KA	76-131	Champion R7	AC 5
PO	76-131	Champion R7	AC 5

If a new spark plug is required, consult this chart before making purchase. If in doubt, see your local Johnson Dealer or Service Station. This is important. Unless the correct number and make of spark plug is used, consistent fouling of the plug or pre-ignition is likely to be experienced.

If pre-ignition is taking place, the insulator or porcelain exposed within the cylinder will be pitted or partially burned away. In extreme cases, the motor will continue to fire after pressing stop button. Proper functioning of the plug is indicated by a comparatively dry insulator. (Section exposed within cylinder.)

Any tendency towards fouling is noticeable by a black gummy deposit on the insulator. This, however, may not be due entirely to the qualities of the spark plug, but to operation at low speeds for long periods, such as trolling, or during the breaking-in period of a new motor or to the use of more oil than recommended.

Pre-ignition in an outboard motor frequently leads the operator to

believe the carburetor or the gas line is at fault, or the difficulty due to lack of lubrication, causing sluggish action of the motor. The motor, when cold and just having been started, will operate normally for a short period until it heats up, then slow down or stop as though it was starving for gas. In slowing down, it cools off considerably and begins to operate normally again, but only until the temperature of the spark plug rises, then pre-ignition reappears. Pre-ignition is usually accompanied by rattling noises in the motor.

The spark plugs require very little attention other than occasional removal for inspection, cleaning and adjustment of the points. Correct gap setting .025".

The insulator should be wiped off with a dry cloth regularly, especially if operating in salt water, to remove all traces of moisture or residue, which often interferes with starting.

To inspect spark plugs on Models DS and DT, unscrew cover bolt (Fig. 16). Pull cover out far enough to permit its swinging down as shown in Fig. 32.

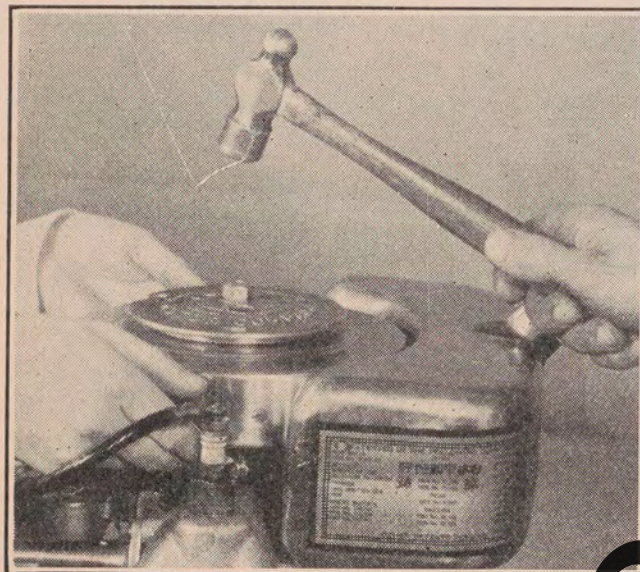

Fig. 33

equipped with a flange, the flywheel cannot be removed in the manner described above.

The flywheel on this model should be removed as follows:

Remove starting pulley, flywheel nut and lock washer. Replace flywheel nut, but turn down only until the end of the crankshaft and top face of the nut are flush. Have someone lift up on the rim of the flywheel (Fig. 33)

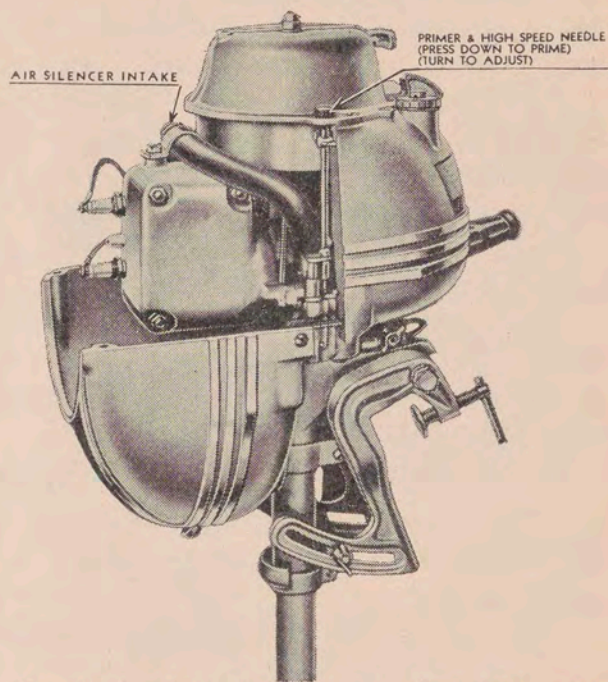

Fig. 32—Showing Cover Down For Inspection of Spark Plugs—Models DS & DT

To Remove Flywheel

If necessary to remove the flywheel, simply unscrew the flywheel nut. This nut has a flange and acts as a puller against the inside of the cover plate. Unscrew the nut until the flange pulls up tightly against the cover plate. Have someone lift up on the rim of the flywheel to absorb the shock. Fig. 33. Strike nut a sharp blow with a hammer.

Should the flywheel continue to remain secured back up farther on the flywheel nut. Strike nut a sharp blow. Several applications of this nature will remove the most stubborn flywheel.

IMPORTANT: Since the flywheel nut on the model 110 is not

to absorb the shock. Strike nut a sharp blow with a hammer. (Be sure nut and end of crankshaft are flush to prevent injury to threads and crankshaft).

To Install Flywheel

First, make certain the keys are properly installed in the crankshaft and **fit snugly**. Remove coverplate from the flywheel. Install flywheel, being careful not to jar the keys loose. Place lock washer and nut into position. Draw up tightly on the nut. Replace cover plate. Have someone hold on to the rim of the flywheel to prevent its turning. Attach large wrench to flywheel nut, strike handle of the wrench with a mallet or heavy hammer to draw up as tightly as possible.

Start the motor and operate it for a short period, after which tighten nut in the same manner. One or two similar applications will properly secure the flywheel.

The hub of the flywheel is made of Lynite and can be split—use discretion. **IT IS IMPORTANT** that the flywheel be securely mounted. A loose flywheel will result in expensive repairs—damaging the hub of the flywheel, the crankshaft and other parts.

A loose flywheel frequently results in a noticeable knock in the motor and consistent shearing of the propeller pin without striking underwater obstructions.

The Shock Absorber

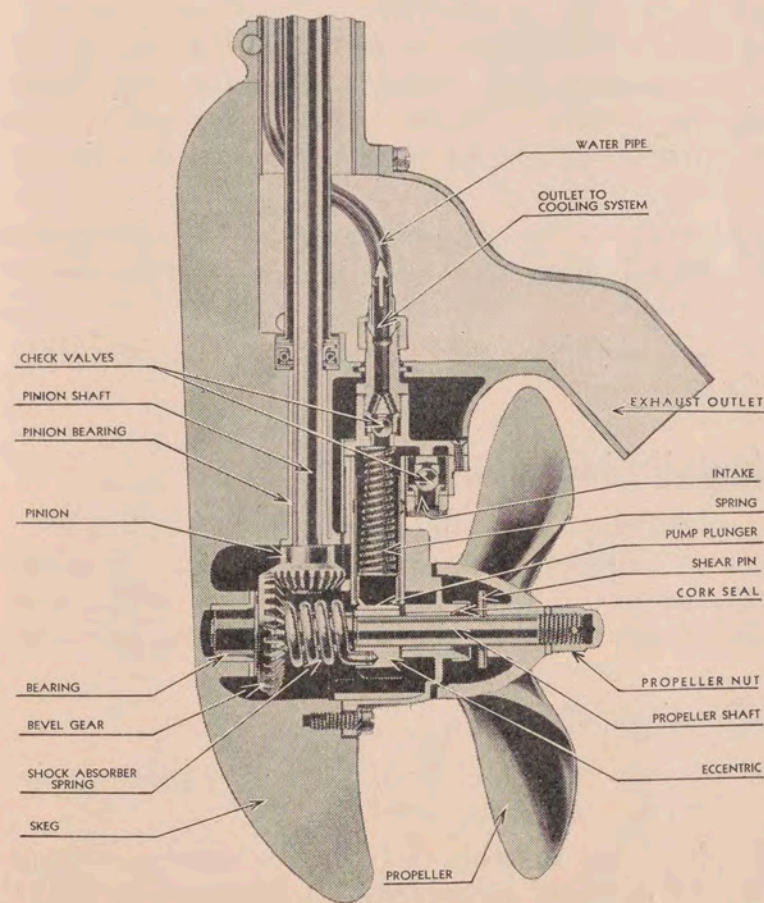

Fig. 34

Models LS, LT, DS and DT are equipped with a shock absorber drive, which provides for driving the propeller through a coil spring attached to the water pump eccentric which is keyed to the propeller shaft and bevel gear. See Fig. 34. Action is such that in event the propeller strikes any underwater obstruction, shock is largely absorbed by the spring uncoiling slightly. This reduces shearing of propeller pins to a minimum and absorbs shocks which might otherwise injure the motor.

Model AA only is provided with a shock absorber clutch—absorbing shock in a somewhat different manner.

It is a simple arrangement, consisting of a tapered bronze cone and

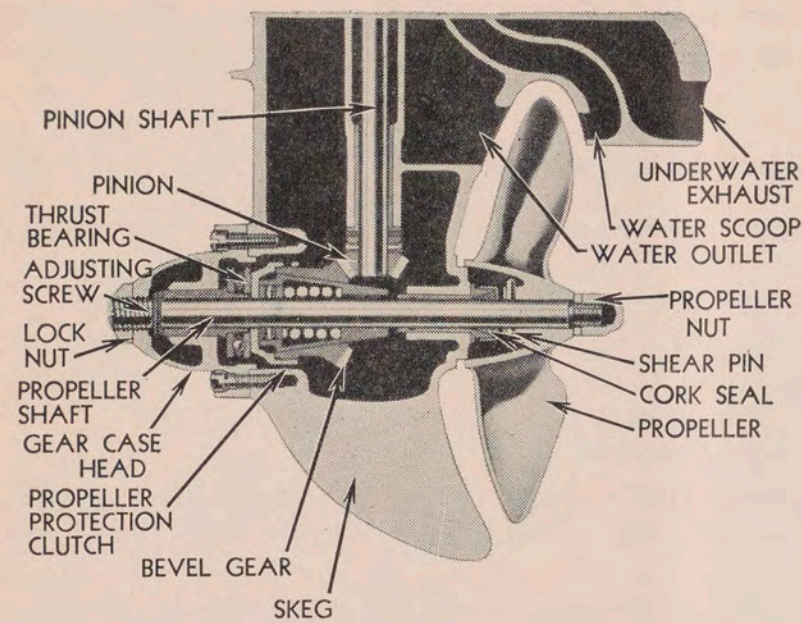

Fig. 35—Gearcase Construction of Model AA

steel sleeve held together by a spring, mounted on the propeller shaft as shown in Fig. 35. Its duty is to act as a clutch, that is, to slip slightly if the propeller should strike an underwater obstruction. This action tends to protect the motor by reducing the forces of shock, also, lightens the burden placed upon the propeller shearpin, resulting in less frequent replacements of the pin.

ADJUSTMENT OF THE CLUTCH. The Shock Absorber Clutch is

adjusted and thoroughly tested at the factory and need cause no concern unless the propeller pins shear too frequently (caused by clutch surfaces sticking). In this case the clutch should be disassembled and the clutch surfaces lapped in with a fine lapping compound, preferably Bon-Ami (powdered) mixed with oil. After lapping, all traces of the compound should be removed by washing with gasoline. Reassemble, coating both cone and seat surfaces liberally with oil to prevent sticking.

Slipping of the clutch surfaces is indicated by spinning or racing of the motor, with little or no boat movement due to the propeller not being properly driven under such circumstances. Make certain, however, this condition is not the result of a sheared propeller pin or cavitation. Investigate immediately.

Note—Upon disassembly of the clutch, both surfaces may be noticeably “ringed” or scored (indication of slippage). To correct, lap surfaces and reassemble as instructed above.

Models 110, 210, KA and PO are not equipped with the shock absorber drive or the shock absorber clutch.

To Install Shear Pin

To install a new shear pin, withdraw cotter pin securing propeller nut. Remove propeller and fragments of sheared pin. Install new pin. Replace propeller and nut. Do not draw up too tightly on nut as this will cause partial shearing of the new pin. Insert cotter pin and lock into position.

The Cooling System

Models LS, DS, LT and DT employ the use of a plunger pump to circulate water thru the cooling system. Fig. 34.

Action of the plunger following the contour of the eccentric, forces water thru the channels and water jackets to provide a cooling medium. The water carries off heat and is expelled inside of the driveshaft housing where it flows out with the underwater exhaust gases.

Functioning of the pump can easily be determined by feeling of the water outlet fittings located near the base of the crankcase. If the pump is operating efficiently, these fittings will be comparatively cool to the touch.

Models 110, 210, AA, KA and PO are NOT equipped with a positive plunger pump but make use of the PRESSURE VACUUM principle described as follows Fig. 35-A.

Water thrown from the tips of the propeller blades is picked up by the water scoop, forced thru the water passages and on into the water jackets to carry off excess heat generated within the cylinders. The discharge is conducted thru a second channel or pipe and emitted from the water outlet in the gearcase immediately forward of the propeller. Action of the propeller and motion of the boat aid in drawing the heated water from the cooling system.

Note—Models 110 and 210 are provided with small pipes to conduct water to and from cylinders, while Models AA, KA and PO have water channels cast into the driveshaft casing, thus the absence of visible water lines. (Water pipes on Models LS, DS, LT and DT are installed inside the driveshaft housing.)

At slow or trolling speeds, pressure of the water thrown from the tips of the propeller blades may not be great enough to force it through the channels and water jackets. Efficient cooling is still maintained, however, by the suction created by water discharging through the return channels. Therefore, since cooling is dependent on both pressure and vacuum at slow speeds, it is IMPORTANT that the motor be speeded up for an instant immediately after starting, to fill the channels and water jackets with water. Failure to do this may result in overheating and seizure—possibly scoring the cylinder walls and pistons.

Overheating is usually accompanied by rattling noises in the motor, causing it to slow down or to stop completely. You should experience no difficulty in determining whether or not such performance is due to overheating—cylinder head should be comparatively cool (warm, but not excessively hot).

Care of the Cooling System (Salt Water Care)

The cooling system of all Johnson motors is designed to operate efficiently with the least amount of attention. Unless there is evidence of overheating, you need not be concerned, except where the motor is operated in salt water.

It is IMPORTANT, when operating in salt water, to flush the cooling system with FRESH water—this should be done as soon as possible after removal of the motor from the boat, to reduce the corrosive effects of salt water to a minimum. Flushing can be accomplished by either attaching a hose to the water scoop and running fresh water through it or by operating the motor in a barrel of fresh water for several minutes.

Salt water, if permitted to remain in the water channels—particularly the water jackets, will set up sufficient corrosion to clog the water passages. Such a condition would naturally interfere with proper cooling and operation of the motor.

The positive plunger pump requires very little attention. Failure to operate may be due to foreign matter lodged on the valve seats or the gearcase having been packed too tightly with gear lubricant. (Fill gearcase as instructed on page 12.) If the motor has been stored for some time it may, prior to using, be advisable to tap the pump body lightly, in event the ball check valves are sticking because of grease or salt water corrosion.

Since models 110, 210, AA, KA and PO do not use the positive plunger pump, it is merely necessary to make certain the water lines and water jackets are clear and free of obstruction. If, however, they are used in extremely sandy water and frequently run over sand bars or rocky sandy lake bottoms, the propeller blades are apt to wear down excessively—to a point where circulation of water through the cooling system is cut off considerably. Any appreciable wear on the tips of the propeller blades will interfere with efficient cooling at slow trolling speeds.

Propellers

The size of the propeller is usually given in two dimensions—the DIAMETER and the PITCH. They are constructed with two or three blades, depending upon the nature of the service.

DIAMETER is the distance from the extreme tip of one blade to the tip

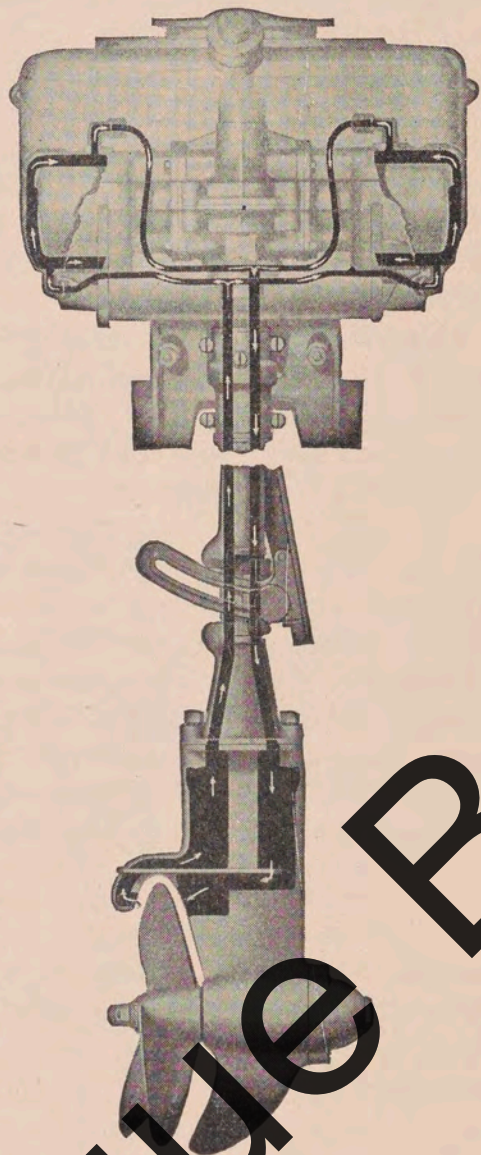

FIG. 35A—Phantom view of Pressure-Vacuum Cooling System.

of the other—two blade type—or the diameter of the circle described by the periphery of the blades—three blade type.

PITCH is the distance the propeller would advance in one revolution, if operating in a semi-solid substance, no slippage being evident.

FOR EXAMPLE—A 10" x 12" propeller will have a ten inch diameter and a twelve inch pitch—theoretically, advancing twelve inches per revolution.

But NO propeller is 100% efficient—certain losses prevail under all circumstances. The percentage of loss or slippage frequently runs as low as 10%, on extremely light racing hulls—and upwards of 40 to 60% on the heavier or cruising types.

EFFICIENCY of the propeller depends, to a great extent, upon the shape and weight of the hull. The light weight HYDRO-PLANE type possibly offers the least resistance to forward motion—therefore—high propeller efficiency. The heavier SQUARE STERN types offer the greater resistance, especially if the power applied is insufficient and incapable of planing the boat—resulting in low propeller efficiency.

Interference—angle of propeller thrust, with relation to the line of forward motion—depth, at which the propeller operates—marine growth, below the water line—and, of course, the load carried are also factors affecting propeller efficiency.

Johnson propellers are designed especially for Johnson Outboard Motors by Johnson engineers to meet the specific requirements of each model. For maximum propeller efficiency, purchase standard Johnson replacement propellers through your local Johnson Dealer or Service Station.

IMPORTANT—Always carry a Johnson designed, Johnson built SPARE propeller—never leave the dock without one.

Model	Part No.	Note	Diam.	Pitch	Blades
110	11-176	*	7 ³ / ₈ "	4 ¹ / ₂ "	2
210	37-170	*	7 ⁵ / ₈ "	5 ¹ / ₂ "	3
LS	41-155	*	8"	4 ³ / ₄ "	2
DS	41-155	*	8"	4 ³ / ₄ "	2
LT	41-156	*	8"	7 ¹ / ₂ "	2
DT	41-156	*	8"	7 ¹ / ₂ "	2
AA	25-73	*	9 ¹ / ₈ "	6"	3
KA	27-275	*	9 ¹ / ₂ "	9"	3
PO	23-126	†	12"	10"	3
	23-39	†	12"	12"	3
PO	23-38	‡	12"	13"	2
	29-175	*	12"	13"	3

NOTES: * Supplied as regular equipment.
 † Supplied as an accessory for very heavy, slower boats.
 ‡ Supplied as an accessory for light weight, very fast boats.

THE WARRANTY ON ANY JOHNSON MOTOR IS VOID IF THE MOTOR IS OPERATED WITH A PROPELLER NOT OF JOHNSON MANUFACTURE, OR IF ANY PROPELLER OF UNSUITABLE SPECIFICATIONS IS USED.

Cavitation

Cavitation should not be confused with a sheared propeller pin or slipping shock absorber.

Cavitation is a condition created whereby the propeller is forced to operate in turbulent or greatly disturbed water. Consequently, air is drawn from the surface into the propeller stream, which, naturally, lessens the load on the propeller, resulting in the propeller being turned at a high rate of speed. However, since the propeller is acting largely on air and turbulent water, its effectiveness is reduced considerably in that the propeller is merely churning the water rather than propelling the boat.

In most instances, cavitation is brought about by the propeller operating too near the surface of the water or to interferences created by the stern being too high. (See recommended stern heights, Page 9.) A wide keel, extended to the stern of the boat, is often responsible for such interference and can be corrected by tapering to a feather edge—commencing approximately two feet forward of the stern.

Collection of grass and weeds on the gearcase also causes cavitation.

Bent or damaged propeller blades frequently result in excessive vibration and loss in propeller efficiency as well as to contribute towards causing cavitation.

Care of the Motor

The service obtained from your motor is dependent largely upon the care it is given. The following suggestions will assist you in properly maintaining the motor:

Remove screen from carburetor periodically to free screen and sediment basin of any foreign substance which might have accumulated. Remove and clean screen in tank.

Inspect spark plugs occasionally. Clean and, if necessary, adjust gap. (Correct setting of gap, .025".) Wipe off insulator or porcelain of plug and ignition leads with a dry cloth to remove residue.

Check breaker points as instructed on Page 32.

Be sure flywheel nut is secure.

Draw up on all nuts and screws at least once each season.

Remove drain and vent plugs from gearcase at frequent intervals to drain off water. Refill with MOBIL UNDERWATER GEAR OIL OR SEA-HORSE GEAR LUBRICANT as instructed on Page 13.

Wipe off motor regularly with a damp cloth. A clean motor is readily accessible for inspection and less apt to foul.

Remove propeller periodically to inspect shear pin. Observe condition of propeller blades. (A spare propeller is a good investment—see your local Johnson Dealer.)

Remove carbon from muffler outlets and exhaust ports each season, also from the exhaust passage in the driveshaft housing on AA and KA Alternate Firing Twins. (Excessive carbon accumulation results in loss of power and hard starting.)

Oil thrust socket, reverse lock and swivel bracket and co-pilot at regular intervals. Note—Models 110, 210 and PO are not equipped with the co-pilot.

Always store motor in an upright position.

Additional Care of the Motor When Operated in Salt Water

Operation in salt water presents certain conditions, not common to fresh water operation, due to the corrosive effects of salt water on the exposed motor parts.

The suggestions below will assist in reducing the corrosive effects to a minimum:

Remove motor from the boat immediately after salt water operation. If the motor cannot be conveniently removed, tilt gearcase out of water—rinse bright parts off with fresh water. (Never allow the gearcase to remain in the water, when not in use.)

Flush cooling system with fresh water, either by attaching a hose to the water scoop by operating in a barrel of fresh water for several minutes. This is IMPORTANT.

Rinse motor off with fresh water. Go over all polished parts with an oily cloth.

The ignition leads and spark plug insulators or porcelains should be wiped frequently with a dry cloth to remove residue.

Hard Starting is Caused By:

- Failure to open vent in gas tank filler cap.
- Clogged fuel line, screens (carburetor and tank) and sediment basin.
- Water in carburetor.
- Needle valve not properly adjusted. (See starting instructions.)
- Failure to flush carburetor. (See starting instructions.)
- Fouled or defective spark plugs. (Residue collected on insulator, especially if operated in salt water.)
- Loose electrical connections.
- Corroded breaker points. See Page 32.
- Cut-out closed. (AA, KA and PO.) See Page 31.
- Accumulation of carbon (after long periods of operation) in muffler outlets, exhaust passages (driveshaft housing AA and KA) exhaust ports and piston ring grooves.

Failure To Start

- Vent in gas tank filler cap.
- Fuel valve closed. Fig. 13.
- Tank empty.
- Needle valve not properly adjusted. (See starting instructions.)
- Water in fuel.
- Clogged fuel line, screens and sediment basin.
- Improperly mixed fuel.
- Fouled or defective spark plugs.
- Breaker points corroded and pitted.
- Spark plug leads disconnected.
- Excessive accumulation of carbon (after long periods of operation) in muffler outlets, exhaust passages, exhaust ports and piston ring grooves, causing rings to stick.

If Motor is Dropped Overboard

Recover motor from water immediately, if possible.

Remove fuel tank, fuel line, carburetor, magneto (see Page 34) and spark plugs. Drain all water that may remain. Wash with gasoline.

Work as much water as possible out of the cylinders and crankcase by turning motor slowly in upright and inverted positions.

Pour a small amount of oil into each cylinder; turn crankshaft to distribute oil.

Blow off armature plate with air pressure, if available; wipe with dry cloth. Place in warm dry place, be sure it is thoroughly dried and that no water remains about the coil.

Replace all parts previously removed. Clean and fill tank with fresh fuel mixture. (Make certain no water remains in tank.)

Start motor as instructed and allow to run until you are reasonably sure no water remains.

CAUTION—Do not under any circumstances attempt to start the motor until the armature plate has been thoroughly dried. Remaining drops of water are likely to set up a short circuit which may result in extensive repairs.

If the motor cannot be started, it should be disassembled at once to remove all traces of water clinging to the inside walls and motor parts. Each part should be dried and coated liberally with oil to prevent rusting. This is **IMPORTANT**, the motor should be attended to immediately. Consult your local Johnson Dealer or Service Station.

Preparations for Storage

No Outboard Motor should be placed in storage, especially winter storage, without considering the necessary precautions.

Most IMPORTANT—Remove all plugs in the gearcase and driveshaft housing, marked "drain" and "grease", to allow accumulative water in the gearcase and water remaining in the cooling system to drain off. Failure to take this precaution will result in bursted cylinder block, gearcase and possible injury to water channels and water tubes, due to freezing during the cold winter months. To make certain all water has been drained, rock motor from side to side.

If operated in salt water, flush cooling system with fresh water. See Page 38.

Refill gearcase with **MOBIL UNDERWATER GEAR GREASE OR SEA-HORSE GEAR LUBRICANT**. See Page 12.

Remove spark plugs—pour about a tablespoon of clean oil through each spark plug opening. Turn flywheel slowly to distribute oil on cylinder walls. Replace spark plugs.

Drain all fuel from gas tank, gas line and carburetor. Remove and clean carburetor and gas tank screens.

Under no circumstances should the motor be stored in an inverted position. It should be hung on a rack similar to the manner in which it is mounted on the boat.

Preparation for Spring Operation

Remove spark plugs, attach ignition leads to some part of motor to prevent injury to the coil. Spin motor with rope to blow out excess oil. Clean and replace spark plugs. Install new plugs if necessary. See Page 33.

Tighten all nuts and screws. **MAKE SURE FLYWHEEL NUT IS TIGHT.**

Fill gas tank with properly mixed fuel. See Page 8.

Johnson Motors Parts Distributors and Service Stations

All parts should be ordered from your nearest Service Station or Distributor

ALABAMA

*Masters Motors Co.
422 S. 20th St.
Birmingham
*A. H. McLeod & Co.
Water & St. Francis St.
Mobile

ARIZONA

Nielson Radio & Sptg. Goods
Phoenix

ARKANSAS

Stanley Outboard Motor Co.
115 Maple St.
N. Little Rock
Vaughn Hdw. Co.
Hot Springs

CALIFORNIA

*B. H. Hebgen Co.
326 Market St.
San Francisco.
*Marine Sales & Service Corp.
1361 S. Flower St.
Los Angeles

CANADA

*Outboard, Marine & Mfg. Co., of
Canada, Ltd.
Peterborough, Ontario

COLORADO

Jackson Bros.
231 King St.
Denver

CONNECTICUT

Clapp & Treat, Inc.
68 State Street
Hartford
Dumont Marine Sales
City Dock
New London
The Essex Paint & Marine Co.
Essex
Cook, Newton-Smith Inc.
115 Crown St.
New Haven

DISTRICT OF COLUMBIA

*Nash Marine Supply Co.
903 Water St., S. W.
Washington

FLORIDA

*Baird Hdw. Co.
115 E. Main St.
Gainesville
Dickson-McLeod
229 S. Monroe St.
Tallahassee
Florida Battery & Equip. Co.
314 W. Pine St.
Orlando
Hopkins-Carter Hdw. Co.
139 S. Miami Ave.
Miami
Lew Hewes
841½ Biscayne Blvd.
Miami
Jacksonville Sptg. Goods Co.
229 W. Forsythe St.
Jacksonville

Runyan Machine & Boiler Works
Pensacola
Tampa Johnson Sales & Service
218-20 Tampa St.
Tampa

GEORGIA

*Stubbs Hdw. & Sptg. Goods Co.
121 Congress St., West
Savannah

ILLINOIS

W. L. Masters & Son
800 N. Clark St.
Chicago
Joe Johnson Garage
223 Sixth St.
Rockford
Motor Boat & Eng. Service Co.
Navy Pier - Door 36
Chicago
*Hewes Boat Co., Inc.
Fox Lake, Illinois

INDIANA

Em-Roe Sptg. Goods Co.
279 Washington St.
Indianapolis
Kindig Bros.
2222 Mishawaka Ave.
South Bend
*George N. Meyer
Lake James
Angola

IOWA

Indian Motorcycle Shop
622 Grand Ave., East
Des Moines

KENTUCKY

*Andrew Cowan & Co.
421 W. Main St.
Louisville

LOUISIANA

*Arthur Duvic's Sons
122 Chartres St.
New Orleans
*S. & L. Service & Storage Co.
Edwards & Travis St.
Shreveport

MAINE

Chubb Electric Co.
2 Bridge Street
Augusta
Albert G. F.
24 Forest Ave.
Portland
Asst. T. Gallupe
Ft. Fairfield
Ellis Sptg. Goods Co.
52 Court St.
Auburn

MARYLAND

G. Elmer Stagner
1520 N. Gay St.
Baltimore

MASSACHUSETTS

Allen Harbor Marine Service
Harwich Port

Johnson Motors Parts Distributors and Service Stations

All parts should be ordered from your nearest Service Station or Distributor

Crandall Company
826 State St.
Springfield
*Crandall-Hicks Company
780 Commonwealth Ave.
Boston
Rapp-Huckins Co., Inc.
138 Beverly Street
Boston

MICHIGAN

C. G. Baisch
136 Michigan St., N. E.
Grand Rapids
*Bay City Hdw. Co.
1009 Saginaw St.
Bay City
Michigan Marine Mart
West Main St.
Muskegon Harbor
Irving M.
447 E. Front St.
Traverse City
Michigan Boat Shop
Hawthorn Springs
Robert L. Shand
Winwell
*Henry H. Smith Co.
338 Jefferson Ave., E.
Detroit

MINNESOTA

Motor Power Equip. Co.
Ford Road & River Blvd.
St. Paul, Minn.
Alexandria Hdwe. & Lbr. Co.
Alexandria, Minn.
Duluth Hardware Co.
19-21 2nd Ave., W.
Duluth, Minn.
Paul H. Kinports
928 Third St.
International Falls, Minn.
Larson Boat Works
First St., N. E.
Little Falls, Minn.
Mahowald Cycle Co.
Mankato, Minn.
McClellan Auto Elec.
Virginia, Minn.
Nelson Sales & Service
1503 Hennepin Ave.
Minneapolis, Minn.
Park Machine Co.
199 West 6th St.
St. Paul, Minn.
United Elec. Service Co.
301 E. Superior St.
Duluth, Minn.
Walker Hdwe.
Walker, Minn.
A. C. White Spt. Shop
Brainerd, Minn.

MISSOURI

*Ralph G. Schmitt & Co.
1211 So. Vandeventer Blvd.
St. Louis
*Star Boat & Motor Co.
15th & Blue River
Kansas City

NEW JERSEY

Carl W. Bush Company
518 Broad St.
Newark

NEW YORK

*Automotive Electric Service Corp.
106 West 63rd Street
New York
*F. M. Baker
119 River St.
Saranac Lake
Charles E. Cool
61 Geneva St.
Geneva
Rochester Marine Co., Inc.
48 Scio St.
Rochester
*F. R. Smith & Son
Bolton Landing
Swan Marine Sales Co., Inc.
48 Swan Street
Buffalo
*Syracuse Boat Corp.
935 S. Salina St.
Syracuse

NORTH CAROLINA

Roy W. Parker
Asheville
*Queen City Cycle Co.
209 Market St.
Wilmington

OHIO

Anchor Canoe Livery
(M. F. Cooper, Mgr.)
1007 Bowery St.
Akron
Barnes Boat Mart
3107 Detroit Ave.
Cleveland
Worthy R. Brown & Son, Inc.
Lakeside
*The Cleveland Ignition Co.
1301 Superior Ave., N. E.
Cleveland
*Powell & Clement
420 Main St.
Cincinnati
The Union Supply Co.
27 - 31 Superior St.
Toledo, Ohio

OKLAHOMA

Forests Sptg. Goods Co.
307 N. Broadway
Oklahoma City
Spavinaw Sport Shop
Spavinaw

OREGON

*The Beebe Co.
504 S. W. First Ave.
Portland

PENNSYLVANIA

*Johnson & Towers
126 Arch Street
Philadelphia

NOTE: *Parts Distributors who also Maintain First Class Service Facilities

NOTE: *Parts Distributors who also Maintain First Class Service Facilities

Johnson Motors Parts Distributors and Service Stations

All Parts should be ordered from your nearest Service Station or Distributor

RHODE ISLAND

Gustave L. Heureux
2210 Broad St.
Edgewood Station
Providence

SOUTH CAROLINA

*Johnson Outboard Motor Service
725 Main St.
Columbia

TENNESSEE

Volunteer Motor Co.
119 N. 3rd Ave.
Nashville, Tennessee

*York Arms Company
162 S. Main Street
Memphis

TEXAS

*Cullum & Boren
1509 Elm Street
Dallas

*Lechenger Marine Store
1012 Caroline St.
Houston

Potchernicks
211 St. Mary's St.
San Antonio

VERMONT

Champlain Marine Co. Inc.
Burlington

VIRGINIA

Motor Boat Sales Inc.
3 West Grace St.
Richmond

Tignor's, Inc.
735 E. Main St.
Richmond

WASHINGTON

*Pacific Marine Supply Co.
1223 Western Ave.
Seattle

WEST VIRGINIA

The Gray Roofing Co.
205 Market St.
Parkersburg

WISCONSIN

Bassetts Super Service Station
Minocqua

J. A. Dewyer Boat Works
Eagle River

Gordon Bent Co.
220 N. Washington St.
Green Bay

A. L. Haglun
Care Larson Chev. Co.
Superior, Wis.

A. L. Koch Co.
302 West College Ave.
Appleton

INDEX

SUBJECT	Page
Attaching Motor to Boat.....	9
Break In New Motor.....	11
Carburetor — Adjustment	29
Cavitation	40
Clutch—Adjustment of	36
Co-incidental Exhaust	31
Compression Release—Model PO.....	28
Controls	12
Cooling System	36
Cooling System—Care of in Salt Water.....	38
Co-Pilot—Care and Adjustment.....	10
Cycle—Two Stroke	6
Exhaust Cutout—Automatic	31
Exhaust Cutout—Co-incidental	31
Failure to Start Motor.....	41
Flywheel—How to Install.....	35
Flywheel—How to Remove.....	34
Fuel Mixture	8
Gas Tank Capacity.....	8
Gear Case — Lubrication and Care of.....	12
Hard Starting	41
Johnson Service	2
Lubrication of Gear Case.....	12
Lubrication of Power Head.....	8
Magneto	31
Magneto — Care of	32
Motor — Care of	40
Motor — Care of in Salt Water.....	41
Motor Dropped Overboard.....	42
Motor Registration	4
Mounting Motor on Canoe.....	10
Preparation for Spring Operation.....	43
Propellers	38
Propellers — (Table of)	39
Ready Pull Starter — Care of.....	27
Registration — Motor.....	4
Shear Pin — How to Install.....	36
Shock Absorber	35
Spark Plugs — (Table of).....	33
Specifications — Motor.....	5
Starting	11
Starting and Operating Instructions for Models 110 and 210.....	15
Starting and Operating Instructions for Models LS, DS, LT and DT.....	19
Starting and Operating Instructions for Models AA and KA.....	23
Starting and Operating Instructions for Model PO	25
Starting Mixture	13
Steering and Reverse.....	30
Storage — Preparation for	42
Swivel Bracket — Adjustment of.....	10
Thrust Socket — Adjustment of.....	9
Two Stroke Cycle.....	6
Warranty	3

NOTE: *Parts Distributors Who Also Maintain First Class Service Facilities.

Antique Boat Museum

