

USEFUL
ACCESSORIES

FOR YOUR

Johnson

MOTORS and BOATS

1930



✂

ACCESSORIES
SPECIALLY DESIGNED FOR
JOHNSON
OUTBOARD MOTORS
and **BOATS**

IN manufacturing Johnson Sea Horse motors special care has been taken to provide every improvement that will contribute to the maximum performance of the unit.

For that reason many owners of old model Johnsons, while having motors of fundamentally the same design as the new models, miss these late improvements which contribute so much to the convenience of outboard motoring.

Also the advent of a complete line of Johnson Boats for 1930 makes available many more accessories that are invaluable for the complete enjoyment of water motoring.

These accessories are shown in detail on the following pages of this catalog. A close study of the various items listed will convince you of their practicability to secure the maximum of utility from your Johnson motor or your boat.

JOHNSON MOTOR COMPANY

WORLD'S LARGEST MANUFACTURER OF OUTBOARD MOTORS
WAUKEGAN - ILLINOIS

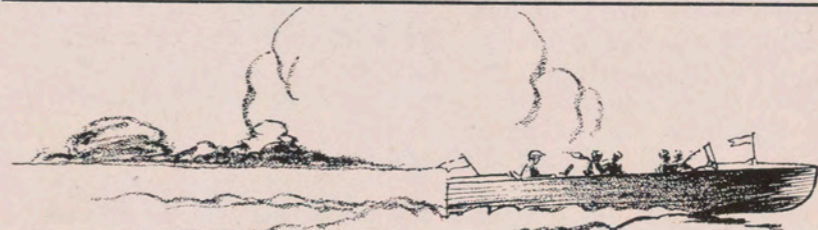

PRICES IN THIS CATALOG ARE ALL F.O.B. FACTORY

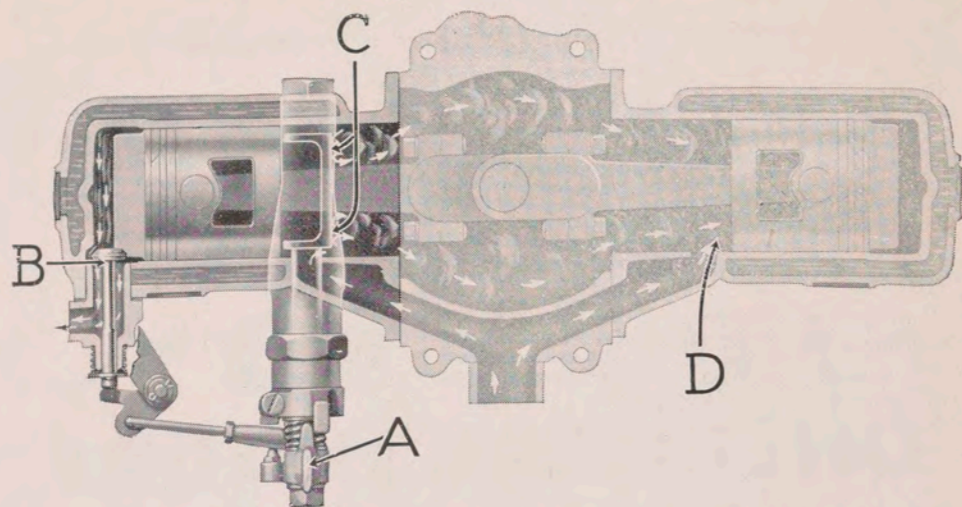

Sectional view of the Johnson power head showing action of Release Charger for positive, easy starting. Lever (A) opens valve (B) releasing compression and closing intake passage (C) in inactive cylinder. Entire charge (D) is forced into active cylinder. The released compression in the inactive cylinder increases the spark intensity in the active cylinder.

The Release Charger

To Give Your 1928 Motor Sure-Fire Starting

WHAT the Self-Starter is to the automobile, the Release Charger is to the outboard. With this device Sea Horse motors start cold, start flooded, start always—and with no more physical exertion than it takes to snap a whip. The Johnson Release Charger releases compression from one cylinder and supercharges the other. This is accomplished by moving the convenient Release Lever which opens a valve in the first cylinder to release compression and closes that cylinder's intake passage at the same time to cut off admission of charges. The charge from the crankcase which is normally distributed to the two cylinders is now forced into the active cylinder.

Decreased resistance at the spark gaps by releasing compression in the inactive cylinder greatly intensifies the spark in the active cylinder. Thus by much greater intensity of the spark in the active cylinder which is already doubly charged with gas, starting is sure and certain. The illustration pictured gives a phantom view of the charger's operation.

The Release Charger may be installed on all 1928 motors with the exception of the Light Single. It comes completely assembled with a new starboard cylinder and it is therefore a very simple matter to attach it to your motor in place of its present starboard cylinder.

... Prices ...

14-406—Release Charger for Model A-35.....	\$12.00
16-152—Release Charger for Model K-40.....	18.00
16-153—Release Charger for Model KR-40.....	18.00
18-187—Release Charger for Model P-40.....	20.00
18-188—Release Charger for Model PR-40.....	20.00

The Underwater Exhaust

Disposes of Fumes and Eliminates Noise

ONLY those who have actually driven a Sea Horse can fully appreciate the enormous difference brought about by the Underwater Exhaust. It subdues the bark of the exhaust while speeding along at a thrilling speed.

Not only is the excessive noise of the exhaust muffled to a quiet hum, but the Underwater Exhaust also carries away the gas fumes from the motor and discharges them below the water. All that remains is the reassuring whir of a smoothly running motor.

The great demand for the Underwater Exhaust has made it possible for Johnson to refurnish this device for Light Twin 1927 motors and all 1928 motors with the exception of the Light Single. The Underwater Exhaust installation consists of a new type muffler and stream lined exhaust pipe extending down into the water just back of the anti-cavitation plate. A valve opens to permit free exhaust of gases above the water when starting or running slow. This operates by a lever connected by a flexible tube. It comes complete ready for attaching to motor. Holes are accurately drilled for bolts and you can attach it with ease. In ordering the Under-

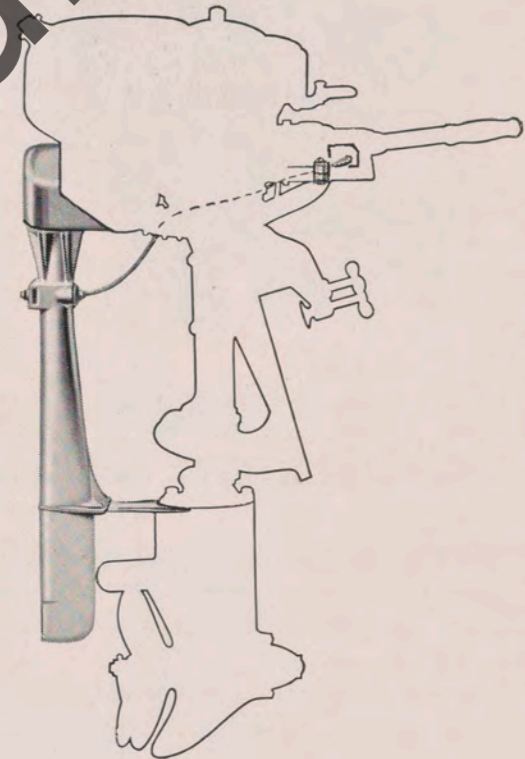

water Exhaust, please be sure to give the model and serial number of your motor.

... Prices ...

14-514—Underwater Exhaust for Model A-35 Motor..	\$12.00
16-168—Underwater Exhaust for Models K-40 and KR-40 Motor.....	16.00
16-175—Underwater Exhaust for Model KL-40.....	18.00
18-203—Underwater Exhaust for Models P-40 and PR-40 Motor.....	\$18.00
18-205—Underwater Exhaust for Model PL-40 Motor.....	20.00

Leak Proof Filler Cap

Fits All Motors

THIS new filler cap prevents gasoline from leaking through the air vent when the motor is being carried or when it is laid down in any position. A valve, hand operated by the knob (see illustration) closes or opens the air vent. Another feature of exceptional value is the fact that you cannot lose this filler cap. A small chain to which is attached a spring clip fits in the opening in gasoline tank, thereby eliminating chance of dropping cap overboard. These filler caps will fit all Johnson motors.

... Price ...

14-45—Leak Proof Filler Cap.....	\$1.00
----------------------------------	--------



ACCESSORY LIST for JOHNSON MOTORS

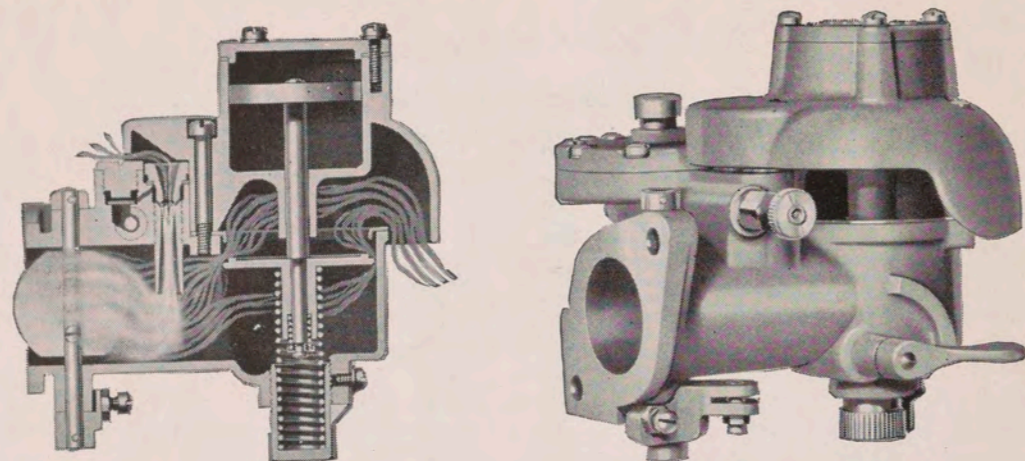

The Vacturi Carburetor

Increases R. P. M. and Power, and Saves 20% to 30% Fuel

THE new Vacturi Carburetor found on some of the latest motor cars can be installed on your 1929 Sea Horse "16" and "32" motors.

This carburetor is so designed that it uses the suction from the crankcase to draw fuel from an auxiliary tank to the motor without the use of any auxiliary pumping mechanism or pressure in tank. It will perform satisfactorily regardless of the location of the fuel tank whether it is mounted above or below the motor level.

Actual running tests have proved that this carburetor saves 20% to 30% on normal fuel consumption by delivering much better carburetion. As gasoline passes through, it goes to two Venturi tubes where it is atomized to a fine vapor and thoroughly mixed with air. This primary mixture is supplemented by a secondary mixture as it passes through the air channel and then through a butter-

fly valve to the crankcase. This efficient atomization increases maximum motor speed 200 to 600 R.P.M.

There are only two adjustments, a needle valve for high speed to regulate the flow of fuel; a slow speed adjustment to regulate air flow. Once adjusted the carburetor supplies the proper mixture throughout the entire range of speed.

There is no float—nothing to get out of order or stick and flood the motor. A spring valve positively shuts off the gasoline flow when the motor is not in operation.

Positive action, simplicity, easy starting economy distinguish the Vacturi Carburetor. Get one for your 1929 Sea Horse "16" or "32"—you will be surprised at your motor's responsiveness to acceleration and the new economy of fuel consumption. Complete instructions for installation sent with each carburetor.

- ... Prices ...
- 76-32—Vacturi Carburetor for S-45, SR-45, V-45.....\$18.50
 - 76-63—Vacturi Carburetor for VR-45..... 18.50

« four »

ACCESSORY LIST for JOHNSON MOTORS

Motor Locks



JOHNSON Locks are an efficient protection against marauders who might tamper with your motor. They lock your motor securely in a tilted position to the stern of your boat. This makes it im-

possible either to start the motor or to remove it from the boat when it is locked. The lock is made of the finest materials and is corrosion and rust proof.

- ... Prices ...
- 76-57 —Motor Lock for Sea Horse "Single".....\$3.50
 - 76-249—Motor Lock for Sea Horse "3"..... 3.50
 - 76-13 —Motor Lock for Sea Horse "4"..... 3.50
 - 76-37 —Motor Lock for Sea Horse "10"..... 3.50
 - 76-14 —Motor Lock for Sea Horse "12"..... 3.50
 - 76-177—Motor Lock for Sea Horse "14"..... 3.50
 - 76-15 —Motor Lock for Sea Horse "16" and "24" ... 3.50
 - 76-20 —Motor Lock for Sea Horse "25"..... 3.50
 - 76-16 —Motor Lock for Sea Horse "32"..... 3.50

Shock Absorber Drive
Break No More Shear Pins

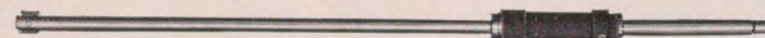

(Only for use in Light Twin Motors below Serial No. 20,000)

WHILE all "Light Twin" and "Light Single" models above the 20,000 serial numbers are equipped with the Shock Absorber Drive, many owners who have models below this number would appreciate this accessory.

After the installation of the Shock Absorber Drive you may drive your boat over sunken tree stumps and rocks in the

go-ahead position, without shearing the propeller pin or stopping motor.

The Shock Absorber Drive merely replaces your present driveshaft. It is equipped with an ordinary cone clutch which will slip upon striking any solid object with the propeller, eliminating the shearing of propeller pins. It is very easily installed.

- ... Prices ...
- 14-173—Shock Absorber Drive.....\$6.00
 - 14-200—Shock Absorber Drive for long shaft..... 6.50

Shock Absorber Grip

THIS grip is made of durable yet pliable rubber and eliminates most of the vibration that may be transmitted to the steering handle of the motor.



- ... Price ...
- 14-306—Shock Absorber Grip.....\$0.50

« five »

ACCESSORY LIST for JOHNSON MOTORS

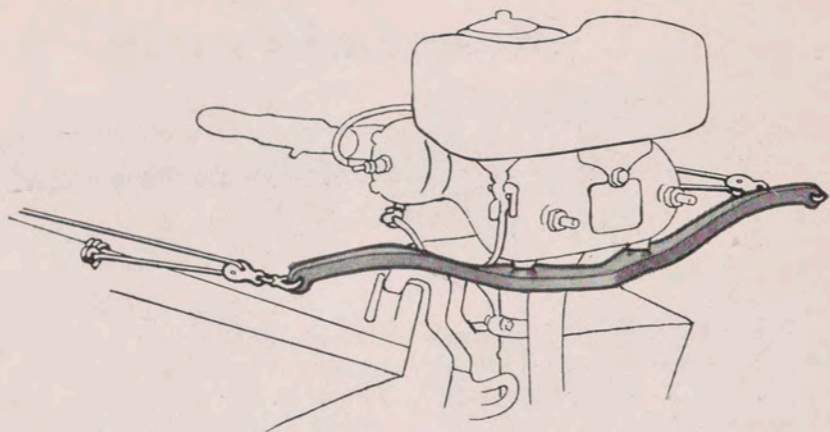

Steering Crossbar for "16" and "32"
Increases the Range of Wheel Steering

IN the higher powered motors such as the "16" and "32," where steered by wheel, a much wider steering range can be had with the use of the crossbar. This is a bar attaching to the rear of the motor below the muffler extending beyond the

width of the power head on each side. Eye bolts for attaching the tiller rope are on each end. This extra length prevents binding of the tiller rope on the motor and allows you to turn the motor much farther in either direction.

Simple to attach.

... Prices ...

76-11—Steering Crossbar for S-45 and V-45 Models... \$4.50

For Racing Motors

76-23—Steering Crossbar for SR-45 and VR-45 Models.. 5.50

NOTE: Racing Crossbar is 36 inches long

☺ ☺ ☺

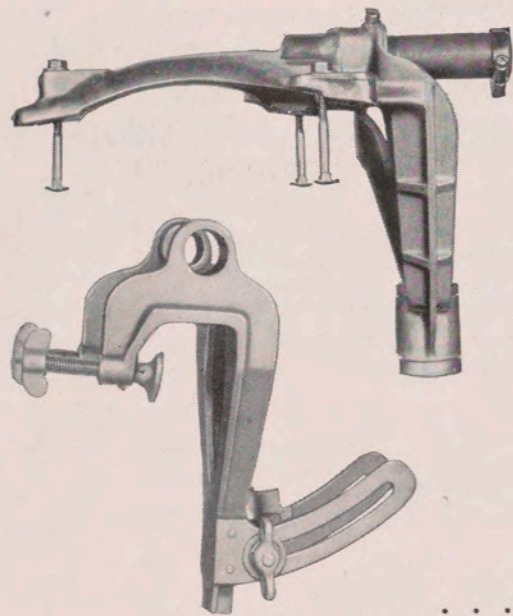

Motor Brackets

For Square or Pointed Sterns

OF TENTIMES after you have installed a Sea Horse "Single" or Sea Horse "3" or "4" on a square stern craft, you want to use your motor on a pointed stern craft or canoe. To meet this need Johnson has designed a canoe bracket. This bracket is interchangeable with the one you have, or if you have a motor equipped with a canoe bracket, you may get a square stern bracket so that you may use your motor on a square stern boat.

Be sure to specify your motor number and model when ordering.

... Prices ...

14-332—Canoe Bracket for all A and J Models..... \$10.00

14-85 —Square Stern Bracket for AC-25, AC-35 and AC-45..... 10.00

14-40 —Square Stern Bracket for JC-25..... 10.00

26-26 —Canoe Bracket for A-50 Models..... 10.00

26-25 —Square Stern Bracket for all AC-50 Models.. 10.00

« six »

ACCESSORY LIST for JOHNSON MOTORS

Extra Length Steering Handle

For Sea Horses "16" and "32"



FOR owners of a Sea Horse "16" or "32" who wish to use their motor in races or who wish to drive their boats from a position farther forward in the boat, Johnson has designed an extra length steering handle with sleeve grip.

This is the same type handle which is now standard equipment in the Sea Horse "16" and "32" except that it is 18 inches longer than the standard length handle.

... Price ...

76-53—Extension for Steering Handle, S and V Models only..... \$10.00

☺ ☺ ☺

Outboard Speedometer

Extremely Simple, Dependable and Accurate

EVERY owner likes to know the speed of his boat in miles per hour. With a Sea Horse Speed Indicator you can tell at a glance how fast your boat is traveling through the water. It is accurate and dependable—easily installed or removed. By watching it you can properly adjust your carburetor and spark; you will find out just what loads to carry; you will know instantly the effect of such conditions on the speed of your boat. No need of testing your boat over a measured course—just glance at the dial and read the speed any time you wish. It is accurately calibrated up to 50 M.P.H. Its operation is very simple. A small streamline tube extends down into the water through the boat bottom. As your boat runs through water, the pressure on this tube increases or decreases directly with your speed. This pressure is transmitted through the flexible tubing to the indicator which registers accurately the M.P.H. of your boat.

Can be installed very easily. Full instructions are included with each instrument.

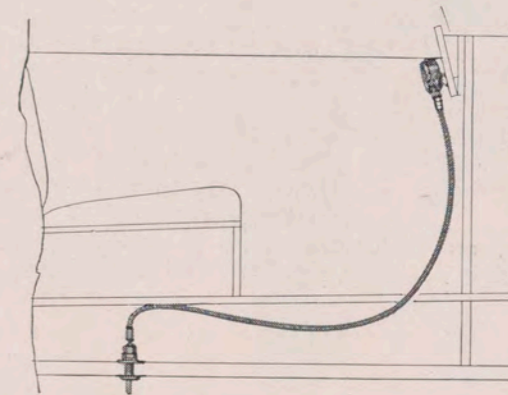
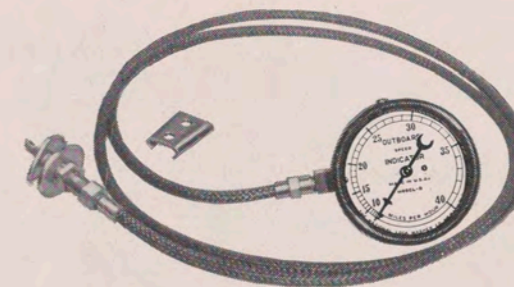

... Price ...

76-17—Outboard Speedometer..... \$18.50

« seven »

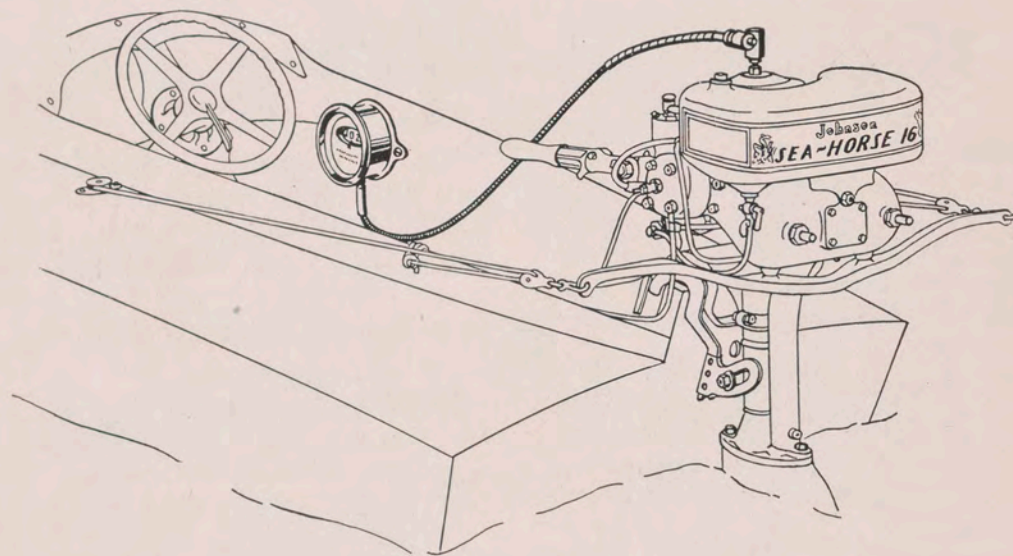

Stewart-Warner Tachometer
Shows Motor Performance

ONE of the most important accessories an outboard pilot can use in racing is a tachometer. With it he can tell by a glance at the recording head his motor's maximum revolutions per minute. He knows exactly what his engine is doing at all times, and he can spot imperfect motor performance that without a tachometer he would never know about. He can try out new propellers, spark plugs, oil and gasoline and check the comparative speeds of each. Not only is a tachometer important in racing, an installation on a runabout or cruiser is very valuable. The performance



on many outboard boats depends a great deal as to whether the motor is in good shape and delivering its maximum power. The tachometer will give you precise information as to what the motor is doing. The Stewart-Warner Tachometer is a reliable, accurate device built on the famous magnetic principle of Stewart-Warner Speedometer. It records motor revolutions from 1500 to 7000 R.P.M. The installation consists of a recording head, flexible shaft and swivel drive nut which can be readily attached or detached while the motor is running. When ordering be sure to specify the model and serial number of your Johnson Sea Horse. If desired, you may order special drive nuts that will enable you to use this tachometer on any model motor.

- ... Price ...
76-18—Model 314-B—Stewart-Warner Tachometer. \$18.00
(Complete with 60-inch flexible drive shaft)

eight

Trolling Device

To Slow the Boat Speed Automatically

FOR fishermen who wish to retard the speed of their boat without retarding the speed of the motor below normal, a special automatic trolling plate has been designed. The illustration at the right is the type of plate to use on the Sea Horse "Single," "3" and "4." The action of this plate is entirely automatic, due to a powerful hinge spring. As the speed of the motor is decreased, the spring automatically lowers the trolling plate which increases water resistance. Speed can be reduced until you are moving at an ideal pace for trolling. As the speed is increased, water pressure from propeller overcomes the spring and raises the plate so that you can travel swiftly to your fishing grounds. It is only a matter of seconds to attach or detach these plates to your motor.

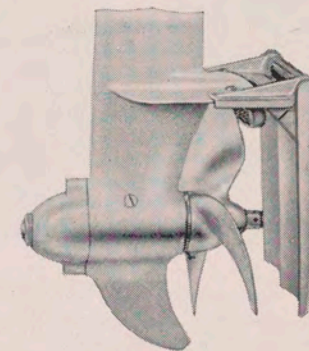

- ... Price ...
76-305—Trolling Plate for "Light Single" and Sea Horse "3" and "4" \$5.00

» » »

Motor Covers

Protect Your Motor

JOHNSON owners desiring to leave their motor attached to the boat overnight, will find this motor cover a valuable accessory. It protects the motor thoroughly from rain and dampness. They are made of fine quality water-proof fabric and are equipped with hookless fasteners, quick to put on or remove.

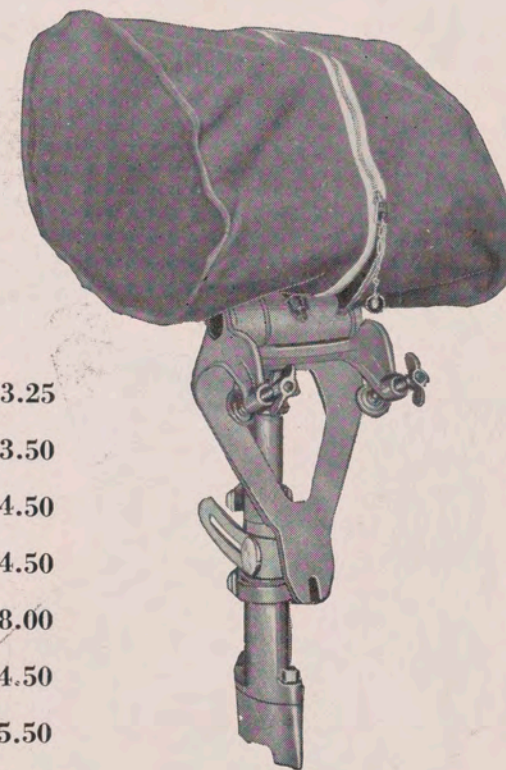

- ... Prices ...
76-56 —Canvas Motor Cover for all J Models \$3.25
76-302—Canvas Motor Cover for all A Models 3.50
76-36 —Canvas Motor Cover for all K Models 4.50
76-219—Canvas Motor Cover for all P Models 4.50
76-43 —Canvas Motor Cover for all T Models 8.00
76-47 —Canvas Motor Cover for all S Models 4.50
76-10 —Canvas Motor Cover for all V Models 5.50
76-25 —Canvas Motor Cover for all A-50 Models 3.50
76-26 —Canvas Motor Cover for all K-50 Models 4.50

nine

Canvas Carrying Case

Clamp it to the Running Board

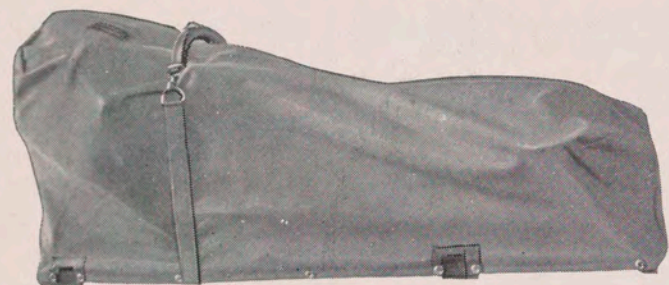

EXTREME PORTABILITY

The extreme portability of your Johnson Motor instantly recommends it for use on week-end trips, vacations, outings, etc. Attaching it to the running-board of your car in the new canvas case is an easy, compact method of transportation.

THIS case can be easily carried or clamped to the running board of your automobile. It offers the utmost protection against dust or rain. One of the outstanding features is the use of the Hookless Fastener. By this arrangement all straps and buckles are eliminated. The motor is mounted in two sockets holding the steering rail and gear case. A spring handle holds the motor securely in place. Rain cannot penetrate the water-proof canvas nor can dust filter through the fasteners and reach the motor.

... Prices ...

- 76-55 —Canvas Case for J-25 and JC-25 \$12.50
- 76-299—Canvas Case for A-35, AC-35, A-25, AC-25, A-45, AC-45 13.50
- 76-64 —Canvas Case for A-50 Models 13.50
- 76-183—Canvas Case for K-35, K-40, KR-40, KF-45 17.00
- 76-65 —Canvas Case for K-50 Models 17.00

~ ~ ~

Fibre Carrying Case

THIS three-ply veneer, fibre-covered carrying case has been designed to permit easy carrying and to facilitate shipment. It is durable and just as conventional in design as your other traveling luggage and a convenience to you that cannot be over-estimated.

Ruggedly constructed of heavy veneer-

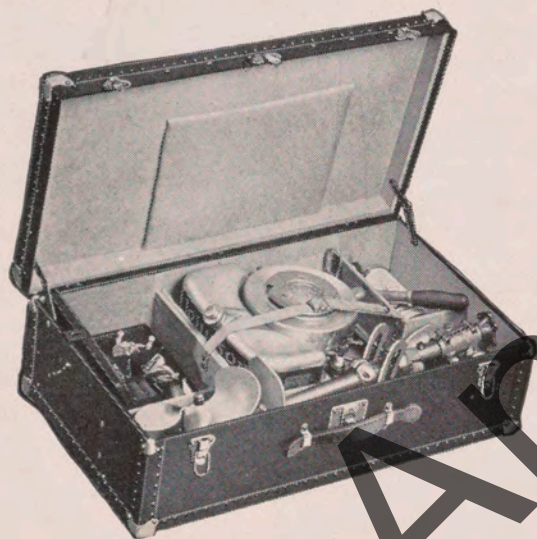

ing and bound with brass hardware, it will stand the hardest usage. Heavy weights may fall upon it, baggage men may throw it about, but no damage can come to the case or the motor inside.

The Sea Horse "3" is easily and quickly taken down for shipment in this case—you need only to remove four screws. There is a compartment for the power-head, one for the lower unit, and one to handle any small extras you may wish to take along. A metal carrying case for your Sea Horse "Single" is also available.

... Prices ...

- 76-262—Fibre Carrying Case for A-35, AC-35, A-25, AC-25, A-45, AC-45. \$18.00
- 76-42 —Steel Carrying Case for J-25 and all A models whose Serial number is below 20,000. 8.00

« ten »

Running Board Clamps

FOR clamping any canvas carrying case on the running board of an automobile, two channel iron clamps have been designed. Openings are provided on the carrying case for inserting the end of the clamps. Thumb screws are tightened to hold case securely in a safe position for travel.

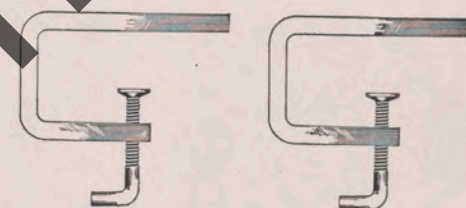

Price ...

- 76-300—Running Board Clamps, per pair \$1.50

~ ~ ~

Spark Plugs

MOTORS used for racing develop much higher internal heat than those used for ordinary purposes. High temperature spark plugs are recommended for racing and spark plugs of moderate temperature for regular use.

The following plugs are recommended as best suited for Johnson Motors.

... Prices ...

- 76-40 —Standard Spark Plug (all small motors) \$0.75
- 76-334—Special for ordinary service, "16" and "32"75
- 76-179—Special Racing Spark Plug (for racing only) 1.50

~ ~ ~

Spark Plug Hoods

THE new Rajah Bakelite Hood will prevent water and spray from shorting your spark plugs and also completely shield porcelain, thereby lessening danger of breakage. Fits all makes of spark plugs and is attached or removed very easily.

... Price ...

- 75-429—Spark Plug Hoods \$0.20

~ ~ ~

Spark Plug Covers

RAJAH Rubber Spark Plug Covers fit over porcelain of plug, protecting it from the water. Especially recommended for use during rain or in rough water where motor may be subjected to spray.

... Price ...

- 76-338—Rajah Rubber Spark Plug Cover \$0.15

« eleven »

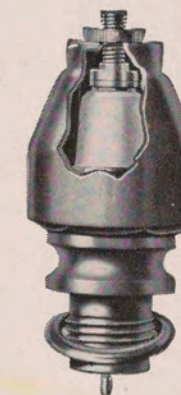
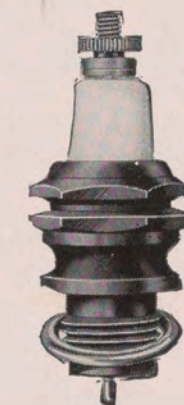

ACCESSORY LIST for JOHNSON MOTORS

Special Ironsides Grease



A WATER proof grease that has been made especially for outboard motors. It will "stay put" in the gear case much longer than ordinary grease and will give the most efficient lubrication possible. Use it in a grease gun.

- . . . Prices . . .
- 76-241—Ironsides Grease, 1-lb. Can. \$0.60
 - 76-256—Ironsides Grease, 4-lb. Can. 1.80

~ ~ ~

Gear Lubricant Tube

EQUIPPED with a nozzle that just fits the openings in the gear-case.

A tube holds a sufficient quantity to fill the Sea Horse "Single" or Sea Horse "3." Two tubes are required on all other models.

- . . . Prices . . .
- 76-307—Gear Lubricant in Tubes. \$0.30
 - Carton of one Dozen. 3.25

~ ~ ~

Form-A-Gasket

THIS cement is many times better than shellac. It can be used for all kinds of gaskets, wherever a perfectly tight joint is desired. It is designed to withstand heat.

- . . . Price . . .
- 76-246—Form-A-Gasket Cement. \$0.75

~ ~ ~

Grease Gun

A QUICK action grease gun suitable for forcing lubricant into gear case with exactly the right degree of pressure. A well made and durable gun that is extremely handy to have around. Very convenient for filling differential on automobile.

- . . . Prices . . .
- 76-245—Grease Gun, Small size. \$1.25
 - 76-22 —Grease Gun, Large size. 1.50

~ ~ ~

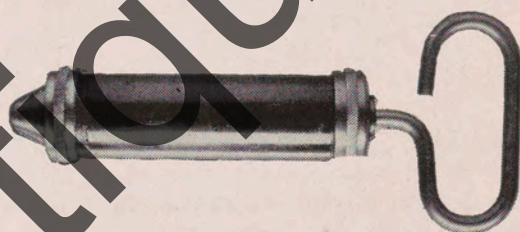

Boat
ACCESSORIES
and
Marine
FITTINGS

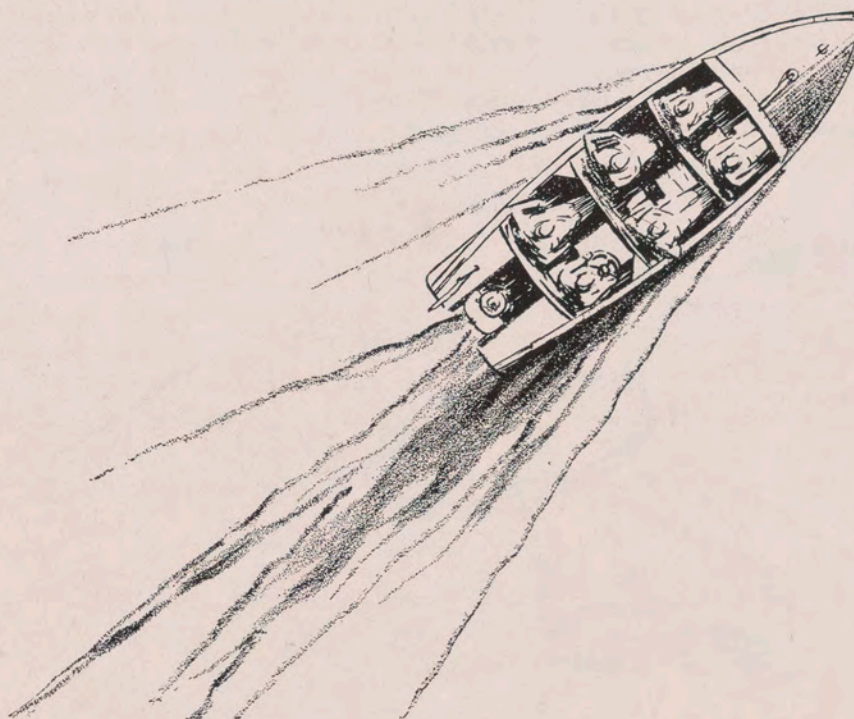

Steering Wheel

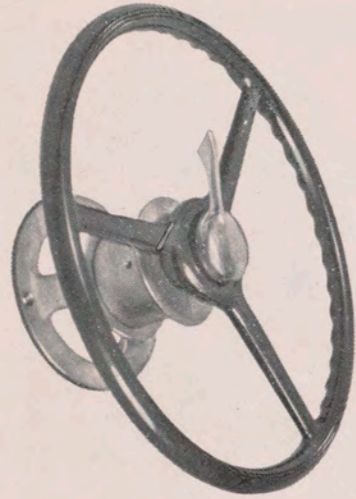

WHEEL steering may be had for any Johnson Sea Horse. The wheel we offer is of the modern automobile type. Rim and spokes are molded rubber, practically unbreakable. It is equipped with a drum to take cable or rope from the motor. Throttle lever is on top of the wheel. The ignition cut-out switch is attached to the throttle lever. The steering wheel comes with metal tubes and wired for complete carburetor control. Can be installed on the floor, bulkhead or thwart of your boat by bracket provided.

. . . Prices . . .

76-108—16-inch diameter Steering Wheel..... \$16.00

Note

22-73 —Remote Control Fittings for S-45 and V-45.... 2.00

» » »

Aquaflyer Steering Wheel

THIS steering wheel with steering column is designed for use on runabouts and can be mounted on either side of the boat. A chain running through the steering column connects with the tiller rope. A system of gear reduction in the steering column eliminates all jerkiness and produces steering as smooth and easy as in motor cars. The rim and spokes on the steering wheel are molded hard rubber

over steel which is the same process used on modern automobile steering wheels. Steering column is polished Lynite, rust and corrosion proof. Stop button, and spark, and gasoline controls are conveniently located at your hand. All wires are furnished and are easily installed. Wheel can be raised or lowered to fit driver's requirements.

. . . Price . . .

76-66—Aquaflyer Steering Wheel..... \$30.00

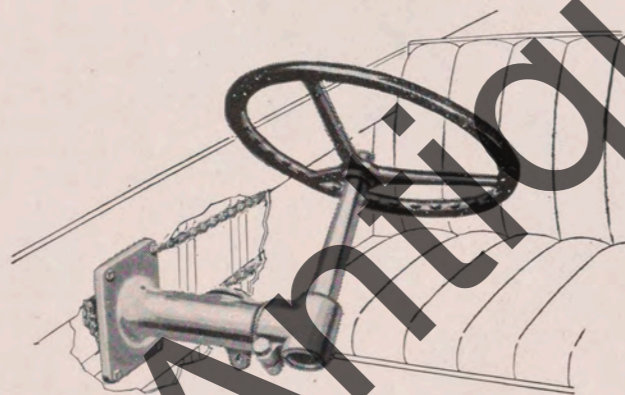

» fourteen »

Fire Extinguisher

GOVERNMENT regulations demand outboard motor boats carry a fire extinguisher. The extinguisher shown here is of one-quart capacity and bears the approved label of the Underwriters Laboratories. It operates as a pump and discharges a fire killing stream 25 feet. The most effective type on oil, grease and gasoline. Contents will not freeze at 50° below zero. It has a brass shell and internal mechanism is made of monel metal which is non-corrosive. Comes complete with full charge and bracket.



. . . Prices . . .

75-37—Fire Extinguisher with Charge and Bracket..... \$12.00

Refills

75-38—One-quart Refill for Fire Extinguisher..... 1.50

» » »

Globe Anchors

Combine Rope Wringer

THE combination Globe Rope Wringer and Anchor eliminates the customary unpleasant handling of wet anchor rope.

The anchor rope passes through a wringer removing all surplus water. A portable spring-latch snubber clamps to the seat and saves tying the rope.

The anchor offers a range of weights from less than two pounds up to twelve pounds, all combined in the one anchor. It will hold fast on any kind of a bottom and will not roll.

The demountable wringer fastens to the bow of the boat with three screws, and the portable anchor clamps over the side or on a square stern.

Just the anchor to hold the row boat while fishing.

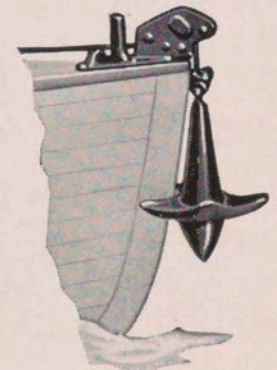
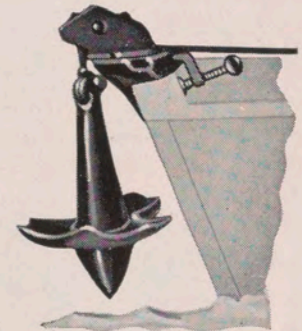

. . . Prices . . .

76-335—Demountable Type..... \$5.00
76-336—Portable Type..... 5.00

» fifteen »

Savage Universal Bracket

Permits Mounting Motor on Cruisers and Large Boats

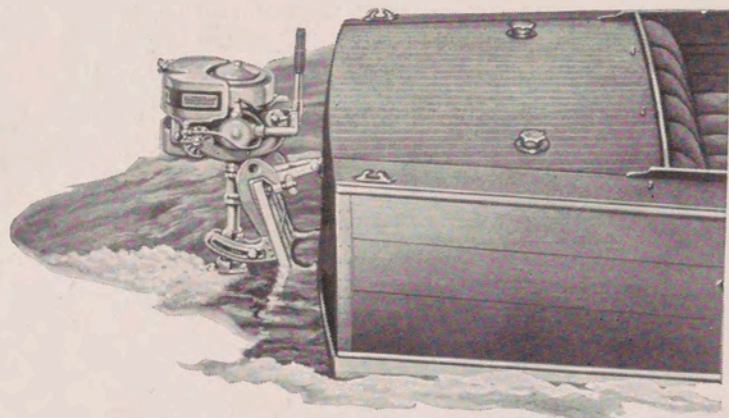

THE Savage Universal Bracket solves the problem of mounting an outboard motor on a large deep boat with a high stern. It permits the use of an outboard motor as auxiliary or emergency power on a sail boat, cruiser, runabout, scow or barge—regardless of the height of the stern and whether or not it is square or overhanging. In case of excessive over-

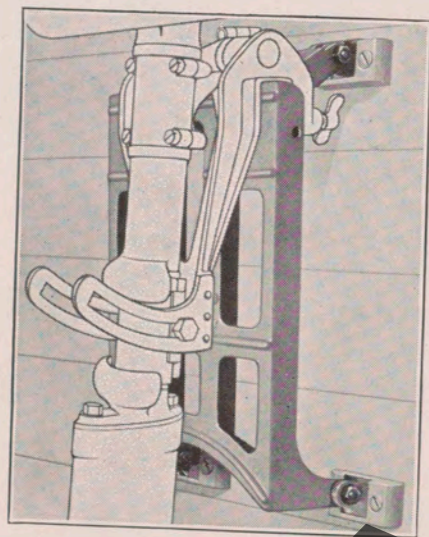

Close-up view showing the method of installation.

hang the Savage Bracket may be mounted on the side of the boat.

The installation of a Savage Bracket with a Sea Horse for power will save many hours of aimless drifting for the becalmed sail boat—with it you will be free from the anxiety and worry in the event of trouble in the main power plant of your cruiser or runabout—it will furnish ample power for trolling with large boats—and it is ideal for heavy work boats, scows and barges using the larger Sea Horses.

The bracket is made of Lynite and is light in weight and neat in appearance. It can be quickly mounted upon or dismounted from the three sockets which are permanently attached to the boat. Illustrations shows method of installation.

... Price ...

76-375—Savage Universal Bracket . . \$20.00

Boat Covers

Insure Clean, Dry Boats

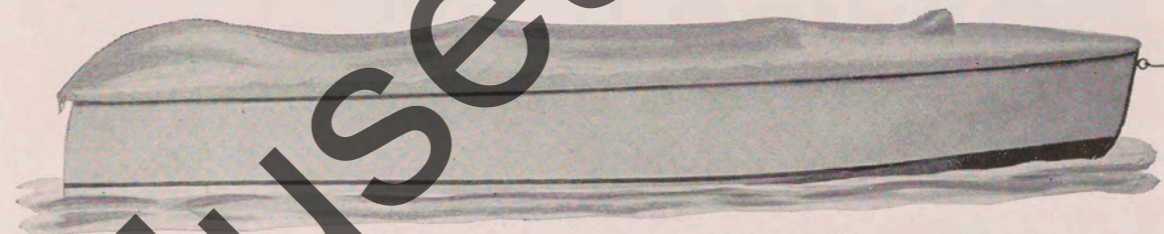

These Boat Covers are made especially for Johnson Boats and will not shrink or pull out of shape. Each cover will fit your boat perfectly.

JOHNSON Boat Covers are designed to fit each model of the new Johnson Boats. They are made in the canvas shops of one of the largest marine sail and cover outfitters and the large quantities in which they are bought assure you of a quality cover at the lowest possible price.

A boat cover is an absolute necessity if you wish to protect the inside of your boat from the ravages of the weather. It will keep your boat looking new. It is only the work of a minute to attach or detach a Johnson Cover, and your boat is always dry, clean and ready to go. They are made of ten-ounce, double filled water-proof duck. Each cover is pre-shrunk thoroughly, so when put on your boat it

will always fit perfectly whether wet or dry. A draw cord system ties the cover on your boat just under the gunnel rail. This is an efficient, easy method, eliminating fasteners which are so easily sheared off.

On the open hatch boats, a motor pocket is attached to the cover while on the closed hatch models the cover fits securely over the hatch. A bow light pocket is provided in the covers used on larger boats.

Every precaution has been taken to provide an inexpensive boat cover that will adequately protect your boat. A cover that is so well made and durable that it should be as lasting as the boat itself.

... Prices ...

- 75-27—Cover for Knockabout Boat BK-30-15 \$14.50
- 75-28—Cover for Class A Utility Boat BU-30-13 14.00
- 75-29—Cover for Class B Utility Boat BU-30-15 16.50
- 75-30—Cover for Service Runabout Boat BS-30-17 23.50
- 75-32—Cover for DeLuxe Runabout Boat BD-30-17 25.00
- 75-31—Cover for 20-foot Aquaflyer Boat BF-30-20 28.00

Auxiliary Fuel Supply Tank

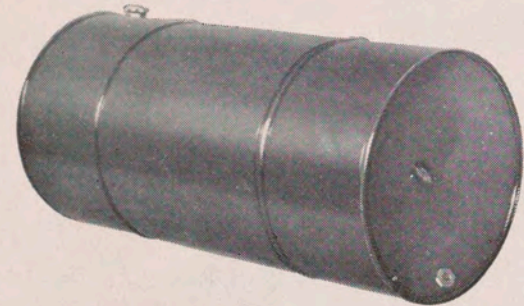

THIS 15-gallon auxiliary fuel tank is made of heavy lead-plated steel and comes complete with all necessary fittings for gasoline connections. Baked enamel finish makes tank corrosion and rust proof. Just the tank for your runabout or cruiser.

For outboard marathon races and long trips to out of the way places.

... Price ...
76-27—Auxiliary Gasoline Tank.....\$12.50

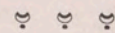

Emergency Fuel Cans

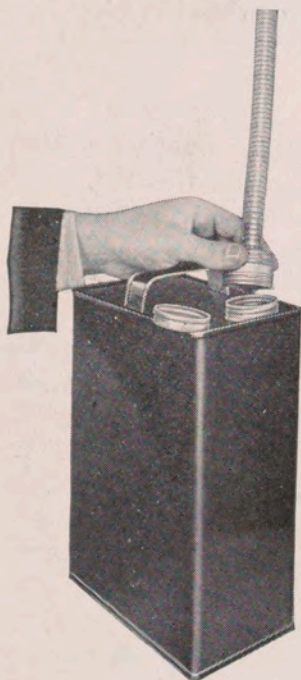

THESE fuel cans are carried in your boat or car for emergency use. The outlet has a nozzle six inches long of flexible tubing that can be inserted in the gasoline tank opening to facilitate filling in rough water and prevent leakage. The cans are made of heavy gauge lead coated steel and are painted a brilliant red to conform to government regulations.

... Prices ...
76-373—Emergency Fuel Tank (1-Gal. Capacity).....\$1.25
76-374—Emergency Fuel Tank (2-Gal. Capacity)..... 2.00
76-19 —Emergency Fuel Tank (6-Gal. Capacity)..... 4.00



Filtering Funnel



MUCH of the hard starting and poor performance of outboard motors can be traced to particles of dirt or water in the gasoline. This funnel will put an end to the trouble. A 100-mesh bronze wire screen in the bottom removes all dirt or water that might be in your fuel mixture. The funnel is sturdily built and will stand hard knocks. A baffle plate around the top prevents gasoline from splashing out when refilling motor tank in rough water.

Don't confuse this with the ordinary cheap funnel.

... Price ...
75-1—Gasoline Funnel with Filter...\$1.50

Kapok Life Vests

THESE new Life Preserver Vests are filled with the finest Japara Kapok and eliminate the cumbersome tie strings found on most life vests. These vests button in the front and have an attractive well fitting appearance. They are a guarantee of safety while on the water and are very light and comfortable to wear. The illustration below shows the special vest for race drivers. The high collar protects the neck and back of head and also will keep the head out of water in case of an accident.

Also makes a good warm jacket for fall duck hunting.

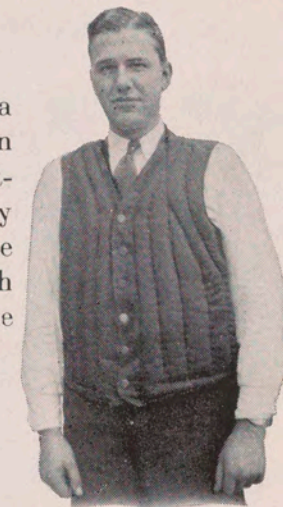

... Prices ...

With Regular Collar

75-33—Small Size 30-34.....\$6.00
75-45—Medium Size 36-40..... 6.00
75-46—Large size 42-46..... 6.00
75-47—Extra Large 48-54..... 7.50

With Buoyant Collar

75-34—Small Size 30-34..... 7.50
75-48—Medium Size 36-40..... 7.50
75-49—Large Size 42-46..... 7.50
75-50—Extra Large 48-54..... 9.00

NOTE: All vests with buoyant collar furnished in either white or brown. State Color and Size

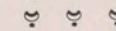

Kapok Life Preserver Cushions

THESE cushions are covered with a good grade of imitation leather and are neatly and attractively welted. They are stuffed with the finest Kapok and will easily sustain a person in the water. The large size listed below will pass Government requirements for life preserver cushions. Furnished in red, green, blue and brown.



... Prices ...

75-35—15x15 inches..\$1.75
75-36—16x18 inches.. 2.75

Canvas Cork Filled Boat Fenders



TO protect your boat from rubbing against the dock when tied up, you should have a set of boat fenders. These fenders are made of heavy sail duck and are filled with ground cork. A brass grommet insures proper fastening for the lanyard line.

... Price ...

75-42—3½x15-inch Canvas Cork Filled Boat Fenders . \$0.85
(Set of six fenders is recommended for boats 15 to 20 feet in length)

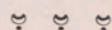

Johnson Sealite Patching Kit



ALL owners of Johnson Sealite Boats should carry one of these kits. Should boat meet with an accident marring the Sealite, quick and permanent repairs can be made easily by simply following the instructions inclosed with kit. Always state model and serial number of boat, giving color of outside.

... Price ...

76-1—Johnson Sealite Patching Kit.....\$3.00

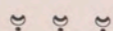

Tiller Rope Steering Device

Steer From Any Place In Boat



FOR those wishing to steer their boat from a position forward, this system of tiller rope is provided. By following the plan shown in the illustration, this system can be easily installed. Eye nuts are standard equipment on all 1927, 1928 and 1929 motors. These models can all be steered easily by this device.

... Price ...

76-304—Tiller Ropes.....\$2.50

(Applicable to any boat)

• twenty •

Yacht Ensign and Burgee

JOHNSON Ensigns and Burgees are made of all wool bunting, clamp dyed and the colors are guaranteed to be fast. They are not to be confused with cotton bunting flags which will shrink and fade in a very short time. Johnson all wool bunting flags hold their shape and color through season after season of use. Strong canvas headings and brass grommets are provided for easy fastening. The Ensign is made up in the regulation manner, thirteen stars circling the anchor and a field of red, white and blue. The Burgee is a brilliant red with three white Sea Horses in relief against the background.

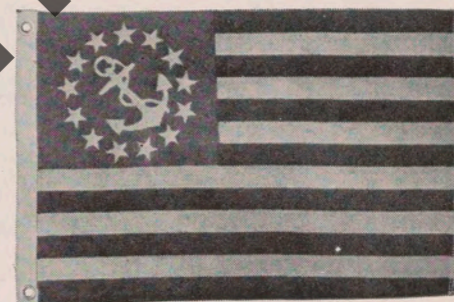

... Prices ...

75-40—Yacht Ensign 16x24 inches.....\$2.25
75-39—Sea Horse Burgee... 1.65

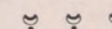

Stern and Bow Flag Poles

THESE poles are made especially for Johnson Boats and turned from solid mahogany, natural finish and coated with clear water-proof varnish. The stern pole is equipped with a combined electric light and pole socket with the latest improved electric connections, so that pole may be removed in five seconds without disconnecting any wires. The bow pole fits in the top of an electric running light having a ¾-inch hole or deck fitting. These poles when carrying your Ensign and Burgee add tremendously to your boat's appearance. The stern pole with light complies with Government regulations which require a white light aft on motor boats under 26 feet long.

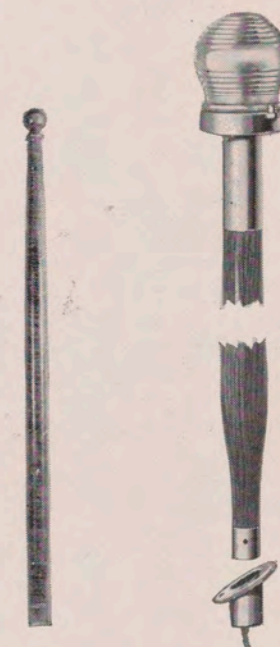

... Prices ...

76-4 —Stern Flag Pole, Light and Socket.....\$8.00
75-41—Bow Flag Pole..... 1.00

• twenty-one •



Folding Boat Seat

THIS seat is adapted for use in row boats, canoes and runabouts not having lazy-backs. It is indispensable to the sportsman and the fisherman. Slips on ordinary boat seat, is light and neat in appearance. Folds compactly and is easy to carry. Ideal seat for the bottom of canoe or boat. Seat is padded with felt and upholstered with black waterproof art leather.

... Price ...
76-28—Folding Boat Seat. \$3.50

Signal Whistle

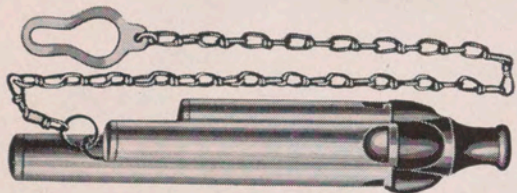

GOVERNMENT regulations require a signal whistle for outboard boats. This whistle is made of solid brass and heavily nickel plated. Bakelite mouthpiece and length of chain. Loud, piercing tone.

... Price ...
75-43—Signal Whistle. \$1.25

Electric Running Light (Bow)

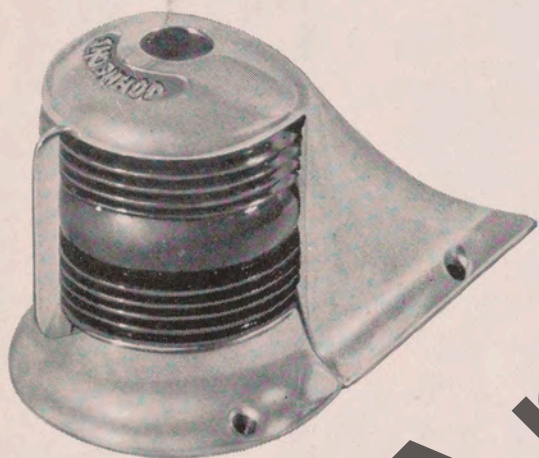

THE beautiful streamline appearance of this light is in keeping with the lines of the modern outboard boat. Highly polished solid nickel silver with a green lens to starboard and a red lens to port. Conforms to Government regulations. 3/4-inch hole in top for bow flag pole.

... Price ...
76-6 —Running Light, 7 inches long by 4 inches high. . . \$6.00
75-51—Extra Lens for Running Light (Red)50
75-62—Extra Lens for Running Light (Green)50

Cleats



These cleats are made of solid nickel silver and are highly polished.

... Prices ...
75-11—2 1/2-inch Fender Cleat. \$0.50
75-12—4-inch Mooring Cleat. 1.00
75-13—6-inch Mooring Cleat. 1.50

Bow Chocks

Highly polished nickel silver to match other Johnson fittings.

... Price ...
76-21—1 Pair Bow Chocks, 3 1/2 inches long. \$1.25



Tiller Rope Pulley

THE very best pulley that can be used on any outboard boat. Made so that it cannot be pulled loose from side of boat. Hard rubber pulley wheel makes quiet operation. Will not rust or corrode.

... Price ...
76-67—Tiller Rope Pulley, each. \$1.25

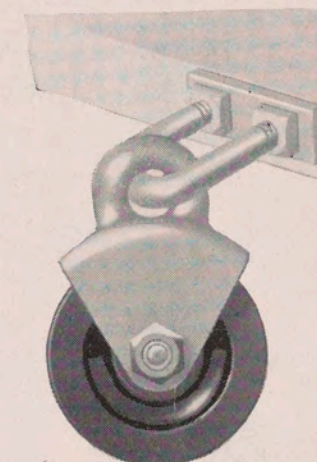

Oar Locks

Highly polished brass oar locks with extra long base.

... Price ...
76-29—Oar Locks, per pair. \$3.00

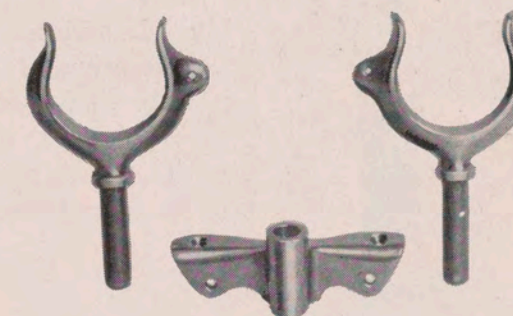

Government Regulations on Motorboats under 26 Feet in Length

SECTION 3.—Every motorboat of Class V (less than 26 feet in length) shall carry from sunset to sunrise (1) a white light aft to show all around the horizon, (2) a combined lantern in fore part of vessel, lower than the white light aft, showing green to the starboard and red to port, so fixed as to throw the light from right ahead to two points abaft the beam on their respective sides.

SECTION 4.—Every motorboat shall be provided with a whistle or

other sound producing mechanical appliance capable of producing a blast of two seconds or more duration.

SECTION 5.—That every motorboat shall carry either life preservers or life belts or buoy cushions sufficient to sustain afloat every person on board.

SECTION 6.—Every motorboat shall carry for immediate use the means of promptly and effectually extinguishing burning gasoline.



Equip your boat with these accessories and you will comply with Government regulations.

Life Vest - - - \$6.00
See Page 19



Kapok Cushion - \$1.75
See Page 19



Fire Extinguisher - \$12.00
See Page 15

YOUR JOHNSON DEALER HAS THEM IN STOCK.

Detailed descriptions of this equipment appear on other pages in this catalog. (See page numbers below illustrations.)

In addition the operator of a motorboat is required to have two copies of pilots rules and regulations in his possession. These can be secured from your local customs officials.



Stern Light Flagpole
\$3.00
See Page 21



Running Light - \$6.00
See Page 22

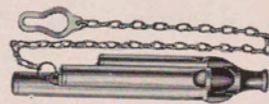

Signal Whistle - \$1.25
See Page 22

« Twenty-four »



Antique Boat Museum